



 **rs barcelona**

Designing to **captivate**. Searching for **beauty in simplicity**. Simplicity that becomes **elegance**. Eliminating the superfluous. Focusing on the **exquisite** nature of the **details** that make an item **unique. Authentic. Exceptional.**

Designing merely for the satisfaction of a job well done. Of **high quality**.

Raising the expert hand of the **artisan**.

The hand which is seldom seen but always perceived. That's where its

**value** lies. Its **honesty**. Designing to

**last. Transcending** the volatility of passing trends with one's own

**personality**. Designing to **transform**

spaces. Bringing a touch of **exclusivity**,

whether subtle or bold, to make each room a space in which to experience

unforgettable moments. Designing to

**be meaningful**. To leave an imprint.

**Respectfully, responsibly and positively.**

At **RS Barcelona** we design with our soul, driven by passion.

**A passion for design.**

Diseñar para **seducir**. Buscar la belleza de la **sencillez**. Sencillez que se convierte en **elegancia**. Eliminar lo que sobra. Centrarse en lo **exquisito** de los **detalles** que lo hacen **único. Auténtico. Excepcional.**

Diseñar sin otra

pretensión que la del trabajo bien hecho. De **calidad**. Elevar la mano

experta del **artesano**. La que, en

ocasiones, no se ve pero siempre se percibe. Ahí radica su **valor**. Su

**honestidad**. Diseñar para **perdurar**.

**Transcender** a la volatilidad de las tendencias con su propia

**personalidad**. Diseñar para **transformar**

espacios. Aportar una nota de

**exclusividad**, sutil o atrevida, para hacer de cada estancia un lugar en el

que vivir momentos imborrables.

Diseñar para **significar**. Para dejar

huella. De forma **respetuosa, responsable y positiva.**

En **RS Barcelona** diseñamos con el alma por pasión.

**Pasión por el diseño.**



---

## Design &

<b>Inspiration</b> • Inspiración	8
<b>Novelties</b> • Novedades	
<b>Track shuffleboard</b> • Shuffleboard	72
<b>Crew stand</b> • Gradas	92
<b>History</b> • Historia	108
<b>Creation</b> • Creación	110
<b>Bespoke</b> • Personalización	112
<b>Commitment</b> • Compromiso	116
<b>Values</b> • Valores	118
<b>Designers</b> • Diseñadores	120
<b>Products</b> • Productos	123
<b>Customisation</b> • Customización	166
<b>Colours</b> • Colores	170
<b>Quality</b> • Calidad	172

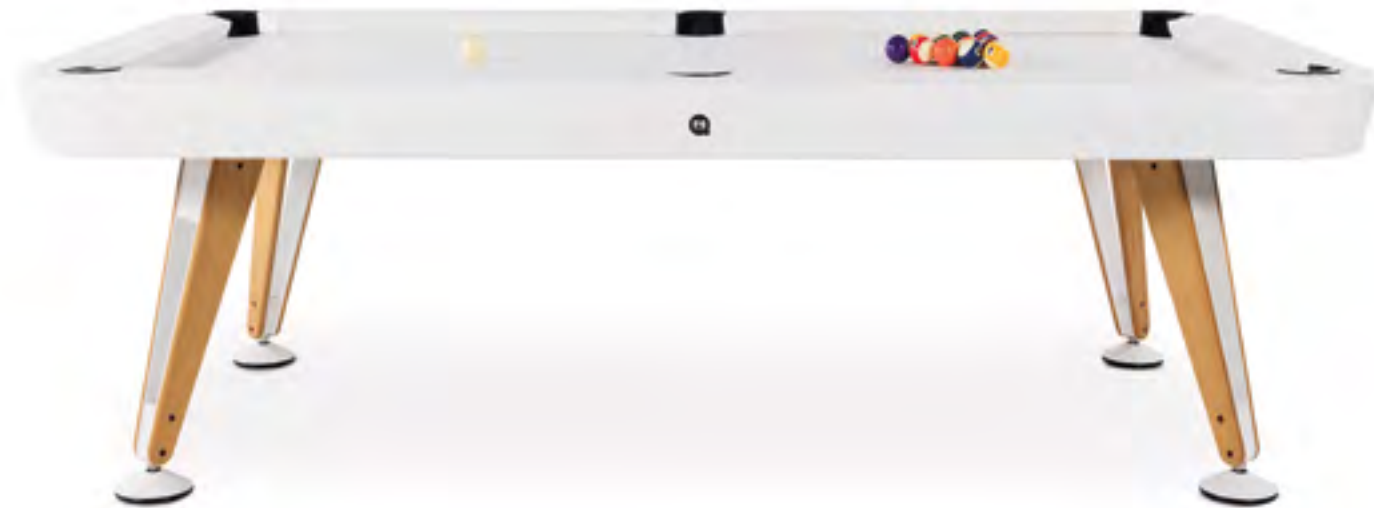

## Show me, touch me, play me.

### Diagonal Outdoor Pool Table · Yonoh

Diagonal is inspired by the perfect lines of the billiard game and by one of the main thoroughfares of Barcelona, the city where it's manufactured. And this is reflected in its design, in the simple forms and ingenious lines that give it a unique and timeless quality. Diagonal strikes the perfect balance between design and playability, and with its sleek and modern lines, it graces any outdoor setting.

Diagonal está inspirado en las líneas perfectas del juego del billar y en una de las calles que vertebraba Barcelona, la ciudad en la que se fabrica. Y eso se transmite en su diseño, en sus formas simples e ingeniosas que lo hacen único y atemporal. Diagonal consigue el equilibrio perfecto entre diseño y jugabilidad y, con sus líneas ligeras y modernas, luce en cualquier ambiente de exterior.



The sun, the breeze and the stars are up for the game.

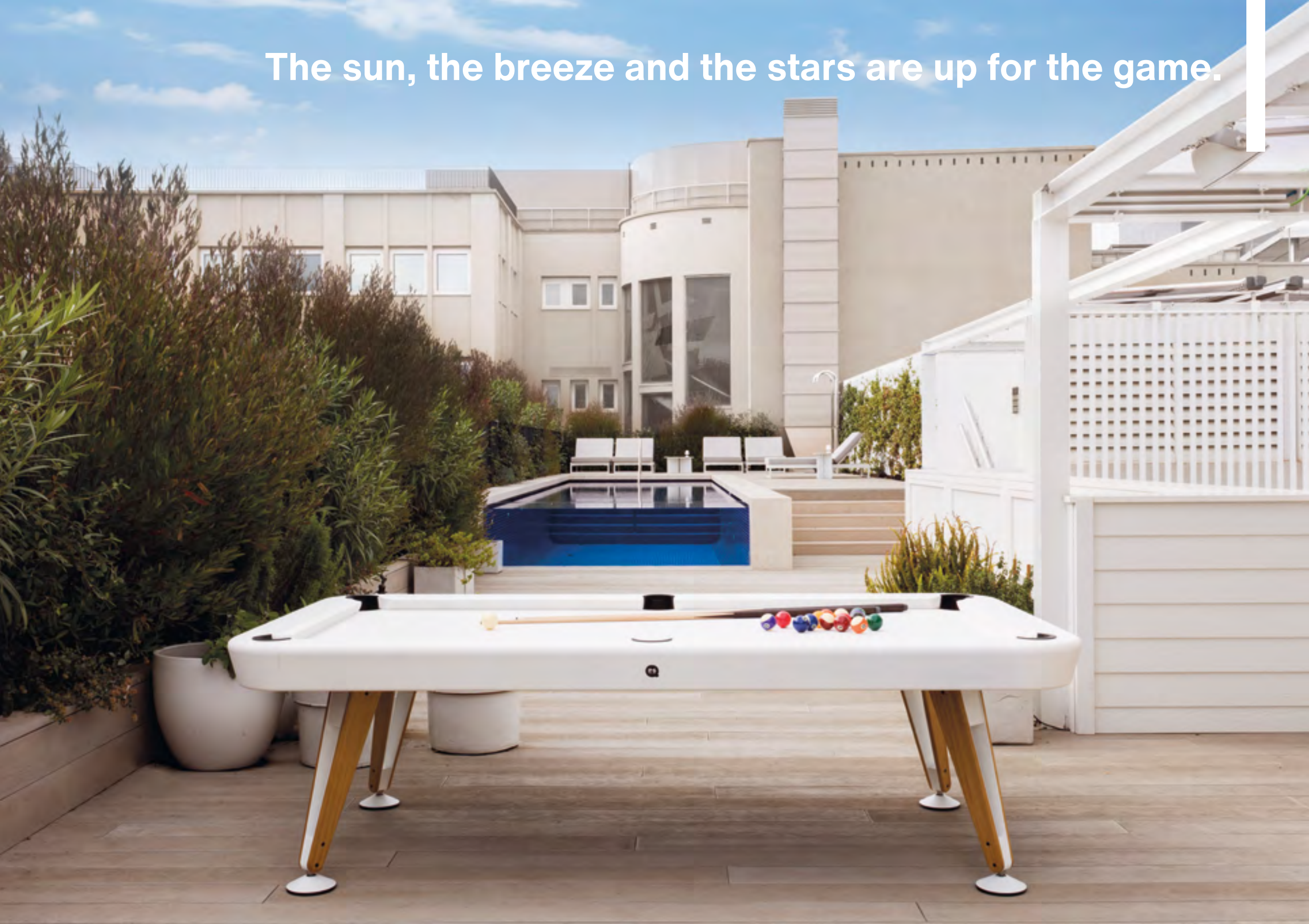



### Diagonal Top · Yonoh



Make the most of the Diagonal pool table with the top.

Food, friends and sunshine.  
Experience your outdoor moments like never before.



# Run the table.

## Diagonal Indoor Pool Table · Yonoh

Just as a diagonal line crosses a space from end to end, the Diagonal pool table imbues any room with design, elegance and playful attitude. Its beauty emerges from its exquisite simplicity, the authenticity of its design and its blend of materials and colours. From sober black to bright white, striking red, subtle elegance of green or deep blue. Appeal for a game of precision and perfection.

Igual que una diagonal cruza un espacio de punta a punta, el billar Diagonal llena cualquier estancia de estilo, elegancia y actitud playful. Su belleza emana de su exquisita sencillez, la autenticidad de su diseño y su mezcla de materiales y colores. Desde la sobriedad del negro y la luminosidad del blanco, hasta la sensualidad del rojo y la elegancia informal del verde y el azul profundo. Poder de atracción para un juego de precisión y perfección.

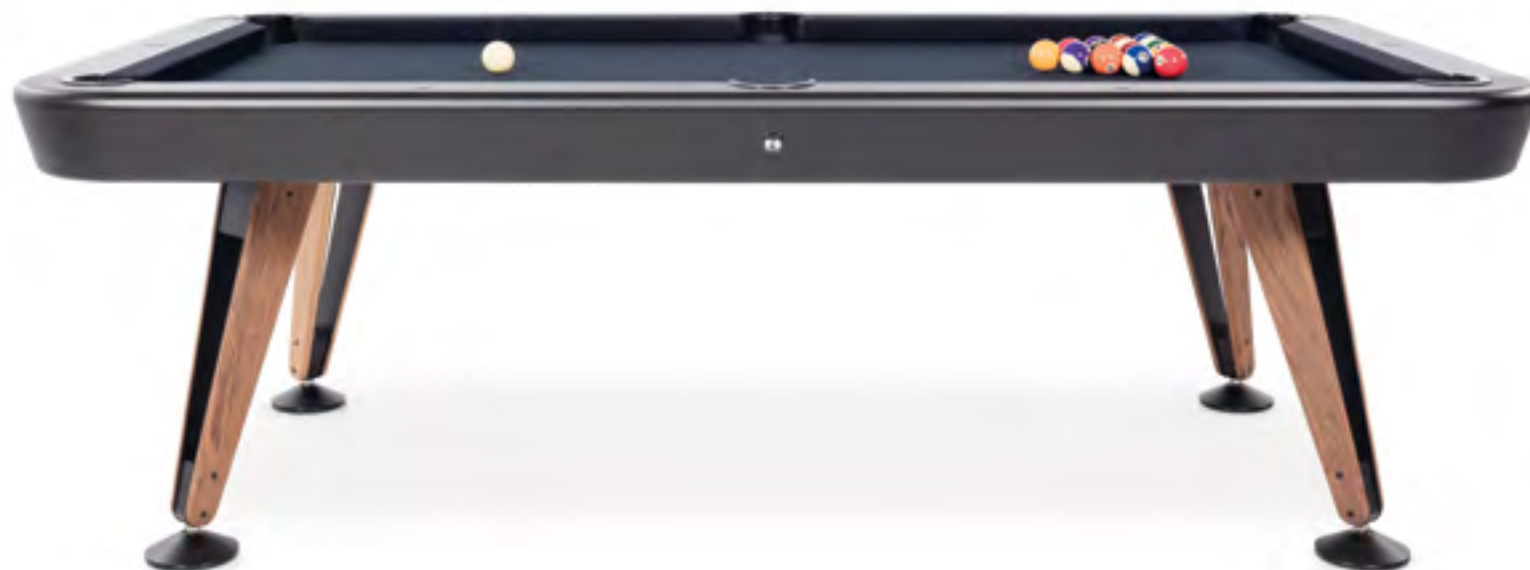







## Harmony. Order.

### Mou Floor Cue Rack · Yonoh

Mou and Diagonal play together as one. The Mou floor cue rack is the perfect mate for the Diagonal pool table. It keeps all your pool accessories safe in the same place. No more leaning pool cues against the wall. No more looking for chalk in every drawer. Each accessory has its own assigned space, and there's even room for other items such as music or drinks, so your pool game can really be a chance to unwind, get away from it all, concentrate on something different, while enjoying some company and the challenge of the game.

Mou y Diagonal bailan juntos en una coreografía de complicidad. El carrito Mou es el complemento perfecto para el billar Diagonal. Permite disponer de todos los accesorios del juego guardados y ordenados. Se acabó tener los tacos de billar apoyados contra la pared. No más buscar las tizas por todos los cajones. En el carrito Mou cada elemento tiene su espacio asignado, e incluso aún hay lugar para otros objetos como tu música o tus copas, y hacer de tu partida de billar una experiencia de auténtica desconexión, evasión, concentración, camaradería y reto.



# Love the game. Love the table.

## You and Me Ping Pong Table · Antoni Pallejà Office

You and Me contains all the moments you can imagine. Working meetings; Monday breakfasts as the clock runs; a family barbecue on the weekend. And it goes without saying that there's plenty of time for many hours of playing too. You and Me is a ping pong table like you've never seen before, with sleek, minimalist lines that suits any interior but really comes into its own in outdoor settings. All the sporting elements- the net, the paddles and the balls -are stored in a discreet side drawer, completely out of sight. And the table is ready for any use you need.

You and Me contiene todos los momentos que puedas imaginar. Reuniones de trabajo; los desayunos acelerados de los lunes; la barbacoa familiar de domingo. Y, por supuesto, muchas partidas y horas de juego. You and Me es una mesa de ping-pong como no habías visto nunca, y con sus líneas mínimas encaja en cualquier ambiente en el interior y, aún mejor, también en el exterior. Toda la deportividad de la red, las palas y las bolas se guarda en un discreto cajón lateral y desaparece por completo. Lista para el uso que le quieras dar.



**An invitation  
to enjoy life al fresco.**



**7:55: Kids having breakfast under the relentless ticking of the clock.**  
 7:55: Niños desayunando bajo el tic-toc apremiante del reloj.

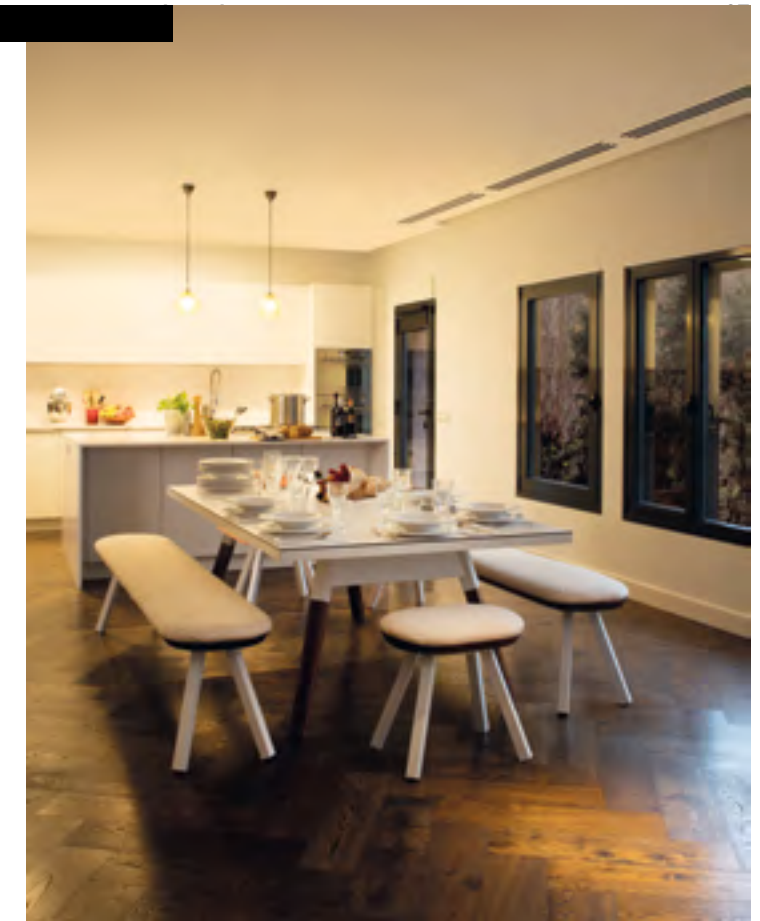

**21:05: Dinner with friends with the whole evening ahead of you.**  
 21:05: Cena con amigos con la noche por delante.

**14:20: 21-point family tournament while lunch is in the oven.**  
 14:20: Torneo familiar a 21 puntos mientras la comida coge su punto de sabor.

Improve your serve.





## Get a grip!

### RS Folding Ping Pong Table · Rafael Rodríguez

With the RS Folding, the sentence “I haven’t got space for a ping pong table” no longer makes sense. It breaks the mould. It restores design to its rightful place, combining the functionality of a folding ping pong table with our intense living design. It remains discreetly tucked away until it’s called into action, revealing all its charm. Once folded, by means of a simple mechanism, it takes up little space. And you can easily move it to the most convenient spot thanks to its tough all-terrain wheels. It will be waiting there for your next game.

Con el RS Folding la frase “No tengo espacio para un ping-pong” pierde todo su sentido. Rompe con todo lo preestablecido. Pone el diseño en el lugar que le corresponde y reúne en una misma mesa de ping-pong la funcionalidad del plegado y nuestro concepto de diseño *intense living*. Permanece discreta y escondida hasta que entra en acción y revela todo su atractivo. Una vez plegada, mediante un sencillo mecanismo, ocupa poco espacio, y puedes moverla fácilmente donde más te convenga, gracias a sus robustas ruedas todoterreno. Allí te esperará hasta la próxima partida.



Rule your ping pong world.





# Play with confidence.

## RS Stationary Ping Pong Table · Rafael Rodríguez

The RS Stationary ping pong table has real character. Its wooden legs give it strength and toughness. It invites you to play with no holds barred, to give it all, because you know that it can handle it. Without question, this is an all-terrain ping pong table. It was inspired by the idea of creating a playmate for the RS3 Wood, our wooden legged football table. They make a perfect couple, sharing outstanding design with strong lines and striking presence. But it has loads of personality in its own right. A ping pong table designed and manufactured for intense play. To last for as many matches as you can ever play.

RS Stationary es una mesa de ping-pong con carácter. Sus patas de madera le imprimen fuerza y resistencia. Invita a jugar sin reservas, a darlo todo, porque sabes que va a responder. Así es: un ping-pong todoterreno. Nació de la idea de crear el compañero de juegos para el RS3 Wood, nuestro fútbolín con patas de madera. Juntos hacen un tándem perfecto. Comparten un diseño imponente, unas líneas firmes y una presencia indiscutible. Y, por separado, se hace valer con su arrolladora personalidad. Un ping-pong pensado y fabricado para el juego intenso. Para durar tantas partidas como seas capaz de jugar.



**We create fun games  
that you'll love.**





**Some days are simply meant for playing.**

### RS3 Wood Football Table · Rafael Rodríguez

The RS3 Wood is the natural progression of our determination to push the boundaries. We've incorporated wood in our football tables and the outcome is a warm and friendly, more contemporary design. The secret lies in the mix, in achieving the balance between the elements so that each one gives its best. We do not choose just any wood. The choice is iroko, a wood suitable for outdoors, that like metal, it's extremely durable and hardwearing, an essential requirement in our range of football tables. The essence remains intact, so you can enjoy the game without having to compromise on design.

RS3 Wood es la evolución natural de nuestro empeño por seguir probando e ir más allá. Introducimos la madera en nuestros futbolines y el resultado es un diseño cálido y cercano, más contemporáneo. El secreto está en saber mezclar, en alcanzar el equilibrio entre los elementos para que cada uno dé lo mejor de sí. No escogemos una madera cualquiera. La elegida es el iroko, una madera de exterior que comparte con el metal su gran resistencia y durabilidad. Dos requisitos fundamentales para formar parte de nuestro equipo de futbolines. La esencia sigue intacta para disfrutar del juego sin renunciar al diseño en una pieza nacida para vivir al exterior.



Go bigger to enjoy it  
to the max.



# The more the merrier.

## RS Max Football Table · Rafael Rodríguez

Go big. Take it to the fullest. The RS Max football table shows that although two is company, three is not a crowd. And even eight is the perfect number to exploit the potential and personality of this football table. The RS Max is the long version of the RS3 Wood. We've resized it to double the fun, accommodating eight players instead of four, making it the ideal game for community spaces and group settings. More players. More laughter. More goals. More excitement.

A lo grande. Al máximo. El fútbol RS Max viene a demostrar que dos es compañía, tres no es multitud y todavía hay lugar para más. Ocho es un número redondo y la cifra perfecta para que este fútbol despliegue todo su potencial y su personalidad a lo grande. El RS Max es la versión alargada del RS3 Wood. Lo hemos redimensionado para duplicar la diversión y convertirlo en el juego perfecto para espacios comunitarios y colectividades. Más jugadores. Más risas. Más goles. Más emoción.



Game for food!







## The icon. ██████████

### RS2 Inox Football Table · Rafael Rodríguez

The RS2 is "THE football table". A spectacular reinterpretation of one of the all-time classics of Spanish game culture. This is where it all began. Our goal was to take the football table out of the garage and move it into the spaces where we do our living. We aimed for it to speak the language of design, dialogue with the furniture and seduce in any environment. A football table that highlights and makes the difference with its industrial design, sleek lines, elegant colours, exquisite details and its long lasting high quality finishes. It has stood the test of time and fleeting trends. Its design lasts and will remain as an iconic piece. For its design, its essence, its significance, and for all the moments that it captures.

RS2 es "EL fútbol". Una espectacular reinterpretación de todo un clásico de nuestra cultura del juego. Con él empezó todo. Quisimos sacar el fútbol del garaje y trasladar el juego a los espacios más vividos. Que hablase el lenguaje del diseño y dialogase con el mobiliario. Que sedujese. Un fútbol que marcarse la diferencia con su diseño de estilo industrial, sus líneas y colores elegantes, con sus exquisitos detalles y sus materiales de alta calidad. Ha superado el paso del tiempo y las tendencias efímeras. Su diseño perdura y sigue siendo y será una pieza icónica. Por su diseño, su esencia, su significado, y por todos los momentos vividos que recoge.







Brilliance and eccentricity at  
the table.



# Eat. Play. Enjoy.

## RS2 Dining Football Table

José Andrés & Rafael Rodríguez

An ingenious idea brought to life in which gastronomy, playtime and design go hand in hand at the most bizarre table in the restaurant. A collaboration with the well-known chef José Andrés, that was born from an idea as simple as original: We put a glass top over our iconic RS2 so it can be used as a dining table without having to stop the game. José Andrés fell in love with our football table and was keen to bring it into his culinary universe. His word was our command. What began as the customisation of our football table for his Jaleo restaurants in Washington and Las Vegas, a very eclectic and Spanish project, became a new piece in our collection.

“The RS2 Dining is an extra ingredient, a special touch in some of my restaurants,” says José Andrés.

RS2 Dining es toda una experiencia en la mesa. Una genialidad hecha realidad, en la que gastronomía, diseño y juego comparten la mesa más excéntrica del local. Una colaboración con el reconocido chef José Andrés que nace de una idea tan sencilla como original: añadimos un sobre de cristal a nuestro icónico RS2 para usarlo como mesa y futbolín a la vez. José Andrés se enamoró del futbolín y quiso incorporarlo a su universo culinario. Dicho y hecho. Y lo que comenzó siendo una personalización de uno de nuestros futbolines para sus restaurantes Jaleo de Washington y Las Vegas, un proyecto muy ecléctico y español, se convirtió en una nueva pieza de nuestra colección.

“La RS2 Dining es un ingrediente más, un toque especial en algunos de mis restaurantes”, dice José Andrés.





## Dive into colours.

### RS2 Football Table & RS2 Dining Football Table Rafael Rodríguez

Colours speak their own language beyond words. A universal language that stirs emotions and provokes feelings. Our new colour chart expresses timelessness and harmony. Colours that convey sophistication and refinement. That inspire with purity and sensuality. That enhance their presence subtly. That together they sum up and they gain in serenity and savoir-faire. Colours that highlight the beauty of our pieces.

Los colores hablan su propio lenguaje más allá de las palabras. Un lenguaje universal que arranca emociones y despierta sentimientos. Nuestra nueva paleta de colores habla de atemporalidad y armonía. Colores que transmiten sofisticación y sintonía. Que emocionan con su pureza y sensualidad. Que, con su sutileza, aportan presencia. Que juntos suman y combinados ganan en serenidad y saber estar. Colores que realzan la belleza y las formas de nuestras piezas.





## The Gold Edition.

### RS2 Gold Football Table · Rafael Rodríguez

Glamour and sophistication into the game. We dress our RS2 football table to the nines. In the Gold Edition, the players jump to the playing pitch with a chrome-plated kit in gold and silver and we add a subtle and elegant touch of brightness in gold colour to some details parts that have made these items all-time classics. It looks like pieces of art. Yes, it is. And, what's more, it is football table to be used and enjoyed as intensely as the rest of our range, but with that touch of sophistication you can expect to find in rarefied settings and ambiances. Because you can also play in a dinner suit or in an evening dress and high heels.

Glamour y sofisticación en el juego. El fútbol RS2 se viste de gala. En la Gold Edition, los jugadores salen al campo con traje dorado y plateado e introducimos un brillo sutil y elegante en oro a los detalles que han convertido estas piezas en clásicos. Parece una obra de arte. Lo es. Pero, por encima de todo, es un fútbol para jugar y disfrutar con la misma intensidad que el resto de la colección. Eso sí, con ese toque chic que respiran ciertos espacios y ambientes. Porque también se puede jugar a fútbol con frac, traje de noche y zapatos de aguja.



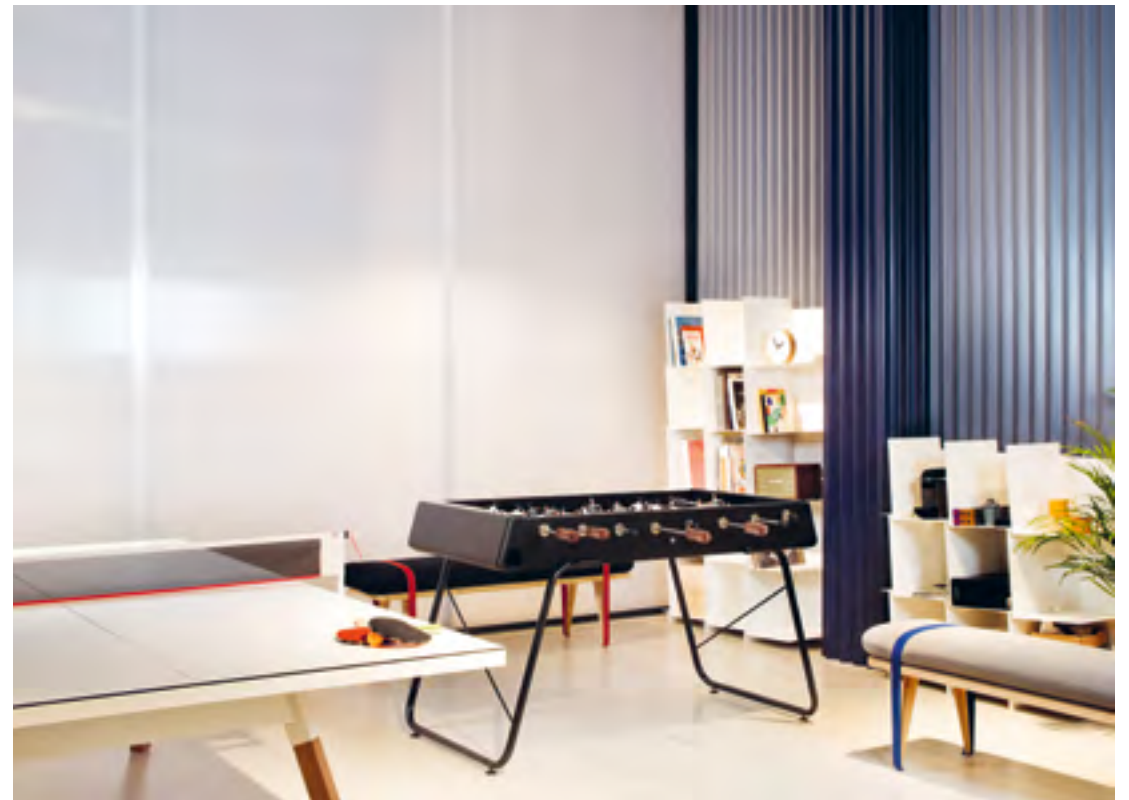



## Pop art is for everyone.

### RS3 Football Table · Rafael Rodríguez

It all begins with "Shall we have a game?" There are winners and losers, but everyone has a great time. Because playing is all about having fun and sharing time together. The RS3 football table injects colour into the game. Its look, with thin legs, is lighter and pop, but the steel structure bestows the same sensations and performances as our entire football table collection: playability, durability and design to enjoy it with the enthusiasm of a child but with the strength of an adult. Because the RS3 is for everyone and it's especially dedicated to all those children who at one time or another have said that "Adults don't play, they just work."

Todo empieza con "¿Echamos una partida?" A veces se gana. Otras se pierde. Aun así, todos se divierten. Porque jugar es compartir. El fútbol RS3 le da color a la partida. Su look, con patas finas, es más ligero y pop, pero su estructura en acero le confiere las mismas prestaciones y sensaciones que todos nuestros futbolines: jugabilidad, durabilidad y diseño para disfrutar como un niño con la potencia de un adulto. RS3 es para todos y está dedicado especialmente para esos niños que alguna vez han dicho eso de "los adultos no juegan, solo trabajan".





**Ella.** ██████████

## Female Football Player

We have always believed in the power of sport as an instrument of cohesion and a link amongst people. Ella is more than just the first female football player. It's a statement of intent for gender equality. Ella was born under the hands of a craftsman who, with great dedication and affection, has carved it with the exact proportions as her male partner. The same skills and precise and powerful shots. The same desire to dribble, make through passes and score spectacular goals. On our football table pitch there are no differences. Ella and her mate play on an equal footing.

Siempre hemos creído en el poder del deporte como instrumento de cohesión y nexo de unión entre las personas. Ella es mucho más que la primera jugadora de fútbol. Es una declaración de intenciones. Nació de las manos de un escultor que, con dedicación y maestría, la talló con las proporciones de su compañero. La misma precisión y potencia de disparo. La misma resistencia y la misma pasión por marcar goles. En el terreno de juego de nuestros futbolines no hay diferencias. Ella y él juegan en las mismas condiciones.





Fill your home with goals and laughter.

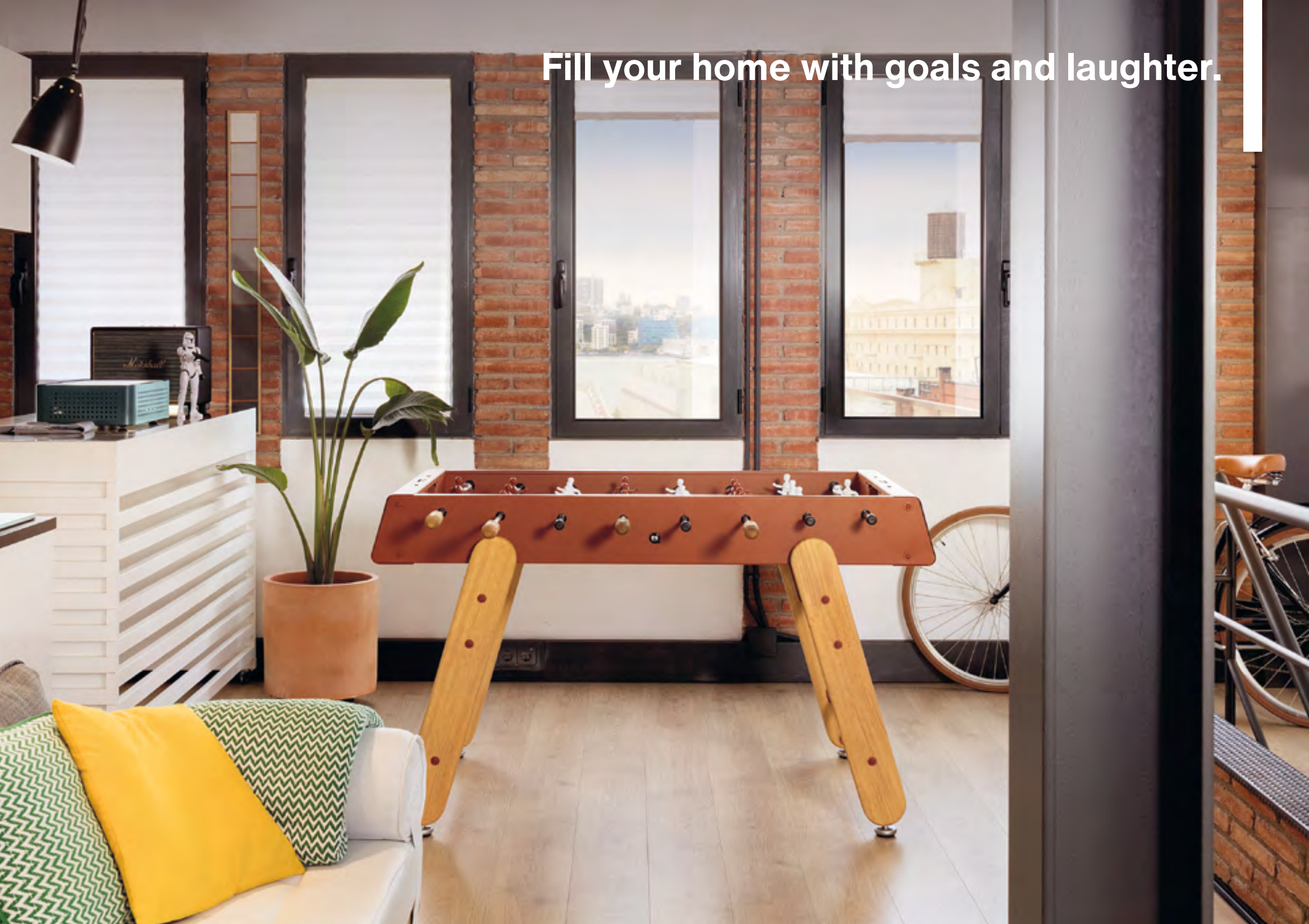



## Do it yourself.

### RS4 Home Football Table · Rafael Rodríguez

The RS4 Home football table has been designed to enjoy at home. For all ages. For sharing with anyone who dares to challenge you. For any moment. It comes with a manifesto in favour of real and authentic fun. Of playing as a family. Of switching off the TV, game console and mobiles to connect with friends. Of rediscovering the active games that make us leap and sweat with excitement. Of "do it yourself". Because putting it together, makes you love it even more. And when the match starts, you set the rules of the game.

The RS4 Home comes completely unassembled to optimise packaging, facilitate shipping and reduce environmental impact without giving up design, high quality and playability.

El fútbol RS4 Home ha sido diseñado para disfrutar en casa. Para todas las edades. Para compartir con todo aquel que se atreva a retarte. Para cualquier momento. Es un alegato a favor de recuperar la diversión auténtica y real. De apostar por el tiempo en familia. De apagar teles, consolas y móviles para conectar con los amigos. De volver al juego activo que nos hace movernos, saltar, sudar y emocionarnos. Del "hazlo tú mismo". Porque cuando lo montas, sientes que es más tuyo. Y cuando empiece el partido, tú marques las reglas del juego.

Viene completamente desmontado para optimizar el packaging, facilitar el envío y reducir el impacto ecológico. Sin renunciar al diseño, la calidad y la jugabilidad.



**It's not how big you are. It's how big you play.**



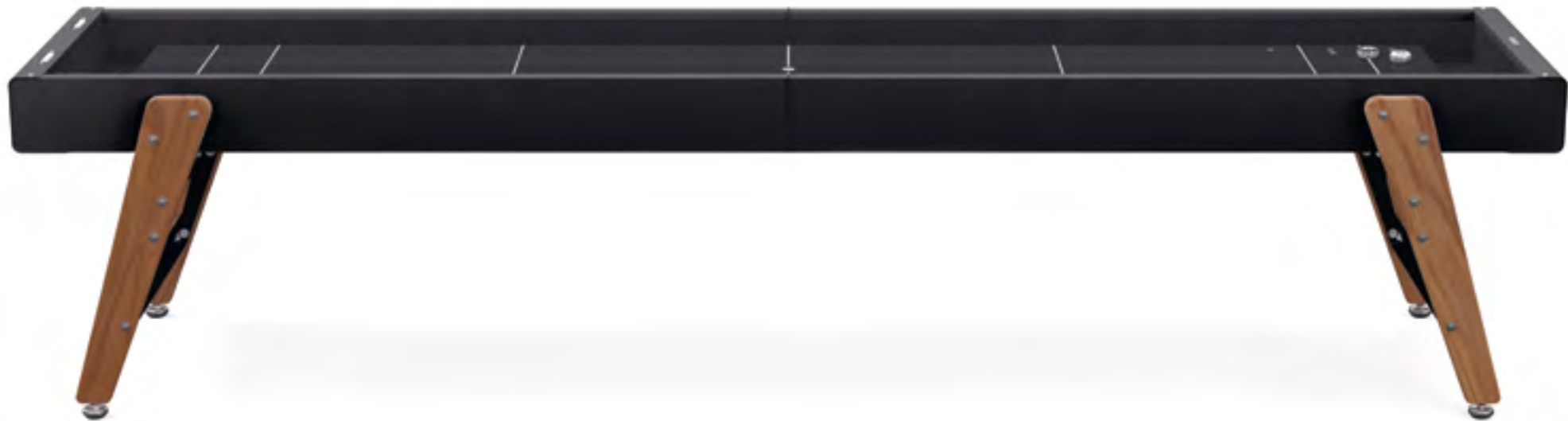

## Reach the limits.

### Track Shuffleboard Table · Rafael Rodríguez

In play, as in life, you have to be bold, challenging the established limits without going beyond them. This is exactly what the Track shuffleboard table is like. Track dares to break the conventions of the classic shuffleboard game, with its design of sleek lines and firm, imposing beauty. It dares to innovate by making tough steel the undisputed star of the pitch. Track gives you a challenge in the distance, with only the path separating you and your desire to win. The precision of your shot connects the departure point and destination: to play.

With its glass top, Track Dining shuffleboard is both a game table and a tall bar table. In fact, the game, with some snacks and drinks to share, has a different flavour.

En el juego, como en la vida, hay que atreverse. Retar los límites establecidos sin sobrepasarlos. Así es exactamente el shuffleboard Track. Se arriesga a romper los clichés del shuffleboard clásico, con un diseño de líneas mínimas y de belleza imponente y firme. Se atreve a innovar con la dureza del acero como protagonista indiscutible del terreno de juego. Te marca un reto en la distancia. Solo la pista te separa de tu anhelo de victoria. La precisión de tu lanzamiento une el origen con el destino: el juego.

Con el sobre de cristal, Track Dining shuffleboard es a la vez pista de juego y mesa alta. Y es que el juego, con unos aperitivos y bebidas para compartir, tiene otro sabor.





**The sensuality of the fold. The power of colour.  
The pleasure of luxury in a fleshy bite.**

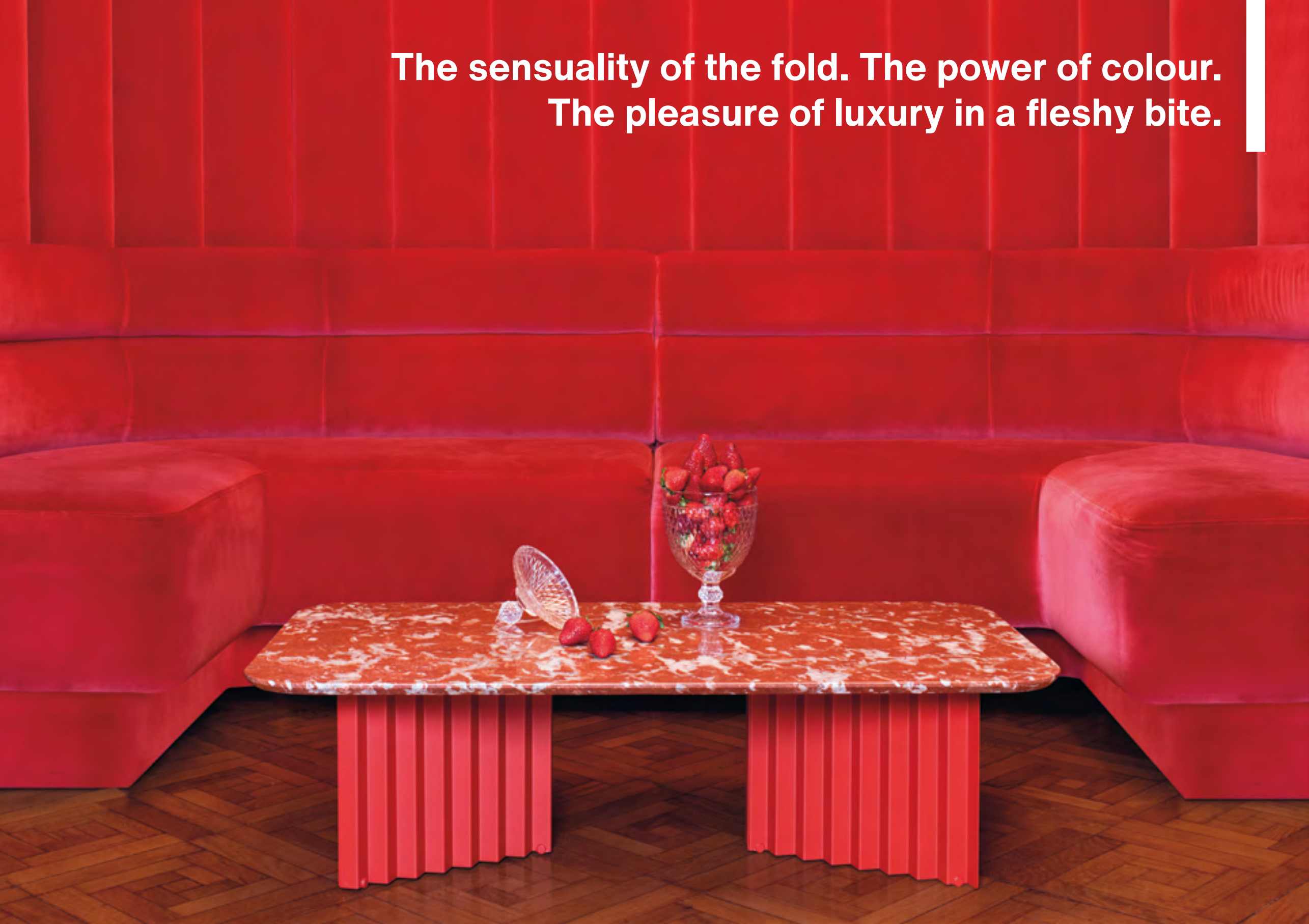



## Reflections of perfection.

### Plec Collection · Antoni Pallejà Office

Plec is a collection of tables that are as happy together as they are apart. With their accordion-shaped legs, they love creating light and shade effects with their symmetrical folds and sensual colours. Their sculptural design, which might seem classical at first, proves capable of adapting to every atmosphere. Metal gives them an industrial feel, and marble, the elegance and authenticity. Colours confer personality and uniqueness. And with the combination of these elements, Plec reveals its savoir-faire. Quiet and restrained presence, without raising its voice, but uncovering the beauty of perfection.

The Plec collection includes rectangular and round occasional tables, a desk and a pedestal.

Plec es una colección de mesas que se llevan bien tanto juntas como por separado. Con sus patas en forma de acordeón, juegan con la luz y crean efectos de luces y sombras con sus simétricos pliegues y sensuales colores. Su diseño escultural, que a simple vista podría parecer de estilo clásico, se adapta al entorno. El metal le confiere la fuerza y el look industrial y el mármol, la elegancia y la naturalidad. Su gama de colores, el carácter y la singularidad. Y con todos estos elementos, Plec muestra su saber estar. Su protagonismo comedido, sin alzar demasiado la voz, pero descubriendo la belleza de la perfección.

La colección Plec se compone de mesas de centro y auxiliares rectangulares y redondas, de un escritorio y un pedestal.







Life is around the table.



# It's all about versatility.

## B-Around Table · Antoni Pallejà Office

No two days are the same. No two projects are the same. No two meetings are the same. No two meals are the same. And no two B-Around tables are ever the same. Versatility is the word that best defines the B-Around table collection. Versatility in shape, size and height. Versatility in functionality: an office table, a conference table, a hot desk, a dining table, a kitchen table or a home desk. Versatility in place: for residential, offices, restaurants and hotels. Versatility in environment, both for indoors and outdoors. To eat. To celebrate. To meet. To work. To get together. B-Around is a table to live as you choose.

No hay dos días iguales. No hay dos proyectos iguales. Incluso no hay dos reuniones iguales. Ni dos comidas iguales. Y nunca dos mesas B-Around son iguales. Versatilidad es la palabra que mejor define a la colección de mesas B-Around. Versatilidad en sus formas, medidas y alturas. Versatilidad en funciones: como mesa de trabajo, de reuniones, hot desk, de comedor, de cocina o escritorio. Versatilidad en el espacio: para hogar, oficinas, restaurantes y hoteles. Versatilidad en ambiente: tanto en interior como exterior. Comer. Celebrar. Trabajar. Reunirse. Encontrarse. B-Around es una mesa para vivirla como elijas.





# The right position.

## Ombra Stool · Emiliana Design Studio

The Ombra stool shows itself as it truly and honestly is. It has nothing to hide. Its simple and clean shape is its own structure. Solid and resistant, with a comfortable, generous and ergonomic seat. It knows that the days are intense and the nights might be long. That's why it waits, discreet but alert for its time to come. Attentive to your conversations at the bar; accompanying you through hard work at the office; sharing a bite to eat on the terrace; waiting for dinner to be ready in the kitchen. It always has a place reserved for you. Get your Ombra and have a nice sit-down.

El taburete Ombra se muestra tal y como es. No tiene nada que ocultar. Sus formas sencillas y limpias son su propia estructura. Firme y resistente y con una sentada cómoda, generosa y ergonómica. Y es que sabe que los días son intensos y las noches se alargan. Por eso espera, discreto, pero alerta a que llegue su momento. Atento a tus conversaciones en la barra del bar; acompañándote en la oficina; compartiendo un bocado en la terraza; aguardando a que la cena esté lista en la cocina. Siempre tiene un sitio reservado para ti. Coge tu Ombra y toma asiento.



Move it and create the perfect viewing stand for the team.



# Believe in the team!

## Crew Stand · Rafael Rodríguez

If our game tables are mini sports stadiums, Crew is the perfect seat to watch the match and cheer on the team. A two-tiered multipurpose seat that invites you to share ideas and experiences, encouraging team spirit and strengthening group dynamics. Its simple structure gives it visual lightness, while the strength of its metal frame provides the stability and toughness to comfortably seat eight people. Crew easily moves from one space to another, offering the functionality and flexibility that inclusive workspaces and common areas ask for. It does not require pre-installation or fixing to the wall or floor, so you can join together as many Crews as you need with absolute freedom of movement and positions. Move it right, move it left. Move it up, move it down, creating the perfect viewing stand for the team.

Si nuestras mesas de juego son mini estadios deportivos, Crew es el lugar perfecto desde donde ver el partido y animar al equipo. Un asiento multiusos en dos alturas que invita a compartir ideas y experiencias, reforzando el espíritu de grupo. Su sencilla estructura le confiere ligereza visual, mientras que la robustez de su esqueleto metálico le aporta la estabilidad y resistencia para acomodar a 8 personas. Crew se mueve fácilmente de un espacio a otro para proporcionar la funcionalidad y flexibilidad que requieren los nuevos entornos de trabajo y espacios comunes. No precisa preinstalación ni anclaje a pared ni suelo, y puedes unir tantas Crew como necesites con total libertad de movimiento y posiciones. Sube, baja. Muévela a la derecha y a la izquierda creando el escenario ideal para tu equipo.









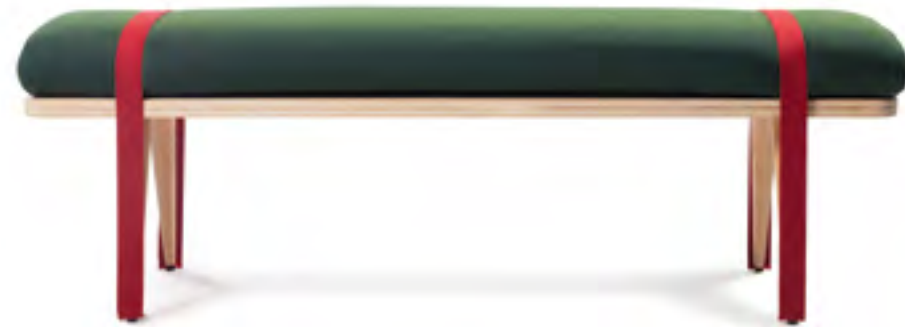

## Simply beautiful.

### On the road Bench · Stone Designs

The On the road bench isn't interested in anything showy or superfluous. Just being itself is all it needs to feel free and to instill its character and essence. It was inspired by a long motorcycle trip on Route 66. Perhaps that's why it prefers you to move it around and put it anywhere rather than treating it as a static, fixed piece of furniture. It prefers to move freely and bring its spontaneity, warmth and coziness to the space it lives in. Put it in your entrance hall, ready to greet you and help you take your shoes off and unwind for a while when you get home at the end of a stressful day. At the foot of your bed. In the middle of your dressing room. In the reception area of the hotel, for the comfort of guests as they come and go. Or in the office, for informal meetings or for resting in the downtime area. You won't be able to resist sitting down on its soft cushion and letting your mind be pulled towards the changing horizon of your own landscapes.

Al banco On the road no le van los adornos ni lo superfluo. Ser él mismo es todo lo que necesita para sentirse libre y transmitir su espíritu y su esencia. La inspiración llegó en un largo viaje en motocicleta por la Ruta 66. Quizás por eso te invita a ubicarlo en cualquier lugar y a no planteártelo como un elemento fijo ni estático. La monotonía no es para él. Le gusta moverse con libertad y llevar su naturalidad y calidez al espacio que habita. En la entrada de casa, listo para recibirte y ayudarte a quitarte los zapatos y el estrés acumulado. A los pies de tu cama. En el centro del vestidor. En la recepción del hotel, para acomodar a los clientes que vienen y van. O en la oficina, para reuniones informales y en zonas de descanso y desconexión. Porque su mullido cojín te provoca a sentarte y dejarte llevar al horizonte cambiante de tus propios paisajes.

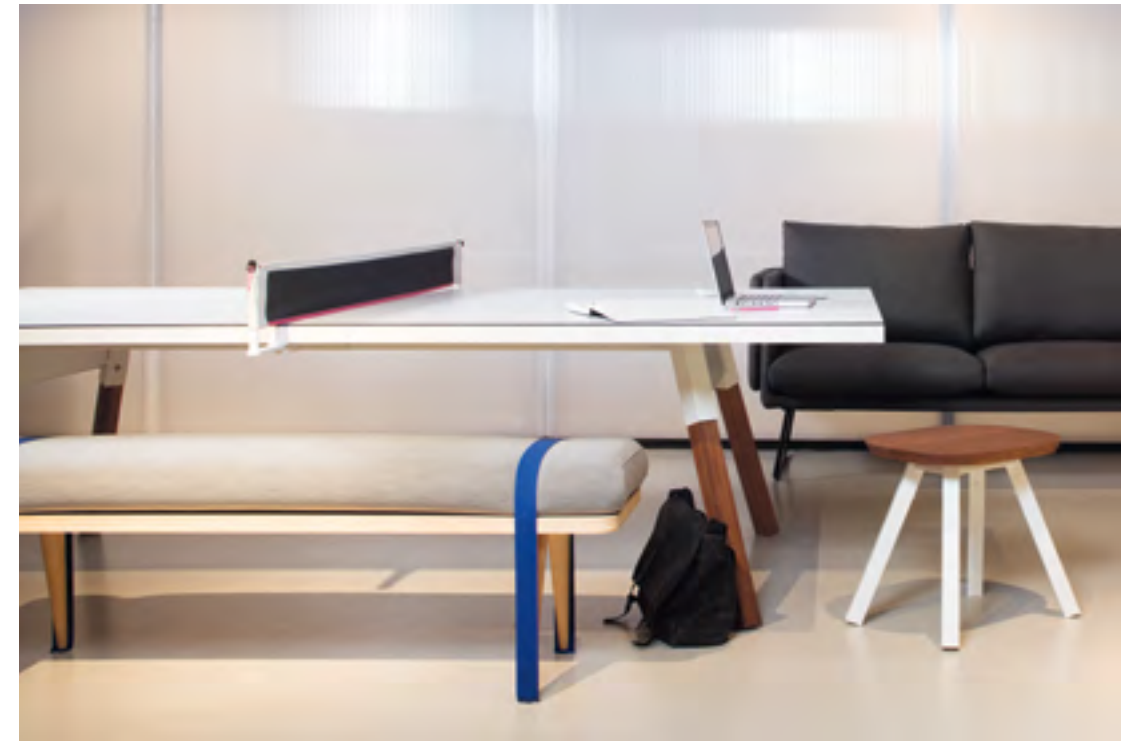

**Tasty moments and  
some tan lines.**





## BBQ, simplified.

### Mon Oncle Barbecue · Mermelada Estudio

The design of Mon Oncle has been a real challenge, a creative adventure. We adopted a fresh and original approach in order to turn an everyday item like a barbecue into something extraordinary. Closed, it's an elegant briefcase with character and a vintage feel. But it's a briefcase with a surprise, because when you open it up, it becomes a fully-functioning and hardwearing portable tabletop barbecue that stores very tasty moments and memories. It's an innovative design that goes beyond the traditional concept of grills to enjoy the flavour of charcoal-cooked meals at any time, in an informal and unplanned way, wherever good company takes you.

El diseño de Mon Oncle ha sido todo un reto, una aventura creativa, con una mirada fresca y original por convertir en especial algo tan cotidiano como una barbacoa. Cerrado, es un elegante maletín metálico de inspiración vintage. Un maletín con sorpresa. Pues, abierto, es una barbacoa de sobremesa portátil, resistente y muy funcional que guarda en su interior momentos muy apetitosos y recuerdos con muy buen sabor. Un diseño innovador que trasciende el concepto tradicional de las parrillas para disfrutar del aroma de los platos cocinados al carbón en cualquier momento, de forma improvisada, allá donde la buena compañía te lleve.



# Hooked on a feeling.

## Wall Champions Coat Rack · Rafael Rodríguez

Wall Champions is a coat rack that was born a footballer. The players of our classic football table have jumped from the pitch to the wall and taken the shape of a coat rack. A piece as useful as decorative and significant. Because in the football universe, colours mean passion. Players are fully customisable with the personality and exclusivity of hand-painted artwork. Male of female, skin tone, and of course, the uniform. Any team. From today or from the past. Make it yours and live your colours.

Wall Champions es un colgador que nació futbolista. Los jugadores de nuestros futbolines saltan del terreno de juego a la pared y toman la forma de un perchero. Una pieza funcional y decorativa a partes iguales y cargada de significado. Porque en el fútbol, los colores son pasión. Los jugadores son totalmente personalizables con la autenticidad del trabajo pintado a mano. Chicos, chicas, el tono de la piel, y por supuesto, la equipación. Cualquier equipo. De ahora o del pasado. Hazlo tuyo y vive tus colores.

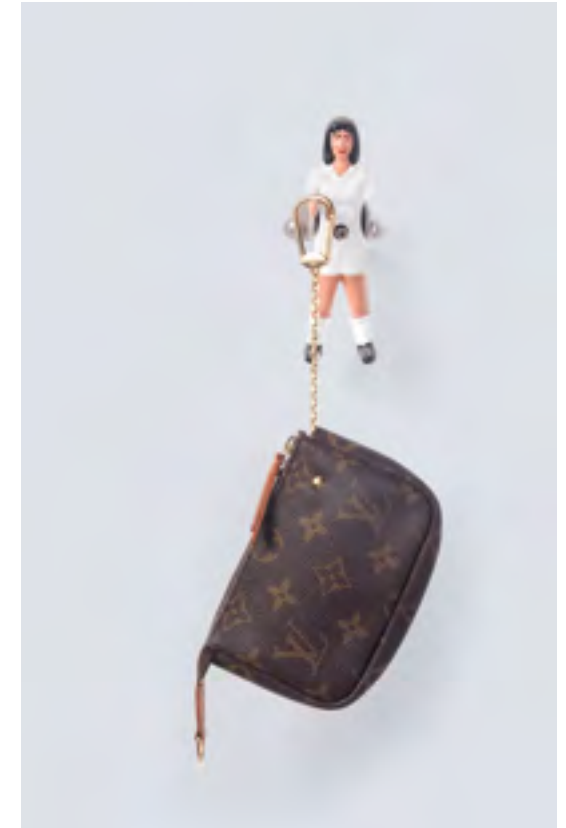
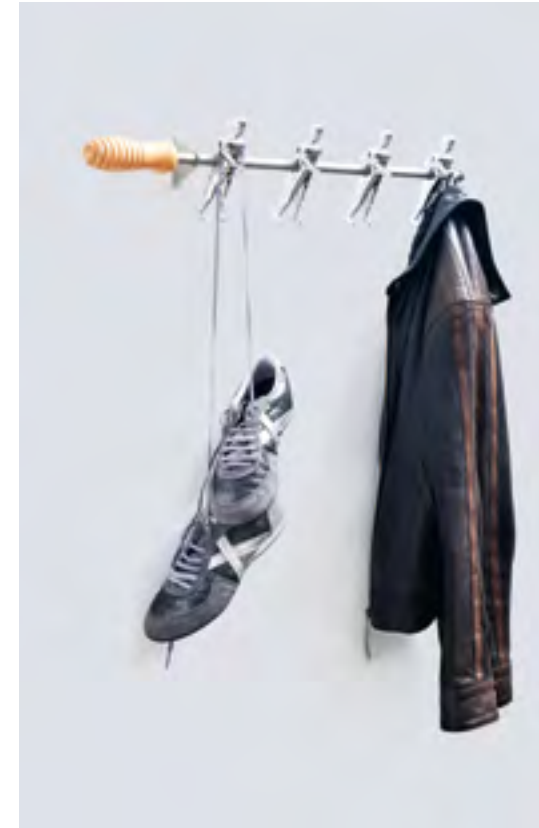



**The wisdom of hands passed down the generations of a family with a metal soul.**

**The passion for a job well done, learnt at the side of a master craftsman.**

**La sabiduría de las manos transmitida de una generación a otra en una familia con alma de metal.**

**La pasión por el trabajo bien hecho aprendida al lado de un maestro del oficio.**

# Design & history

The history of RS Barcelona began in 1975 in a small sheet metal workshop. Rafael Rodríguez Castillo, a seasoned mould maker, decided to set up his own business. Over time, his workshop became an industrial building just outside Barcelona and his two sons, Rafael and Sergio, joined the business. The machines cut, folded and bent metal at a relentless pace and the work soon became monotonous. Working for others put food on the table but it didn't satisfy the creative hunger of the business. It was time for the company to put all the expertise built up over the years into designing a unique product of its own. An iconic design is born: the RS2 football table, taking the football table out of the garage and into the living room, the nerve centre of the home.

Coincidence came into play in 2006, when RS Barcelona came into contact with Vinçon, Barcelona's leading design store, and the RS2 earned itself a prime spot in the store window. This chance encounter gave the company the push it needed to reach for more. More dreams. More products. More progress.

That's how it all began, with a football table. But it wasn't just a product. It wasn't just a game. It was a statement of intent, the essence of intense living: a way to celebrate the beauty of life, inviting us to savour every moment.

That's what we've been doing for the last 15 years. Putting our soul and craftsmanship into everything we do to transmit our passion for design.

La historia de RS Barcelona arranca en 1975, en un pequeño taller de chapa metálica. Rafael Rodríguez Castillo, un matricero con mucho oficio a sus espaldas, decide montar su propio negocio. Con el tiempo, se convierte en una nave industrial a pocos kilómetros de Barcelona; un proyecto al que se unen sus dos hijos, Rafael y Sergio. Las máquinas cortan y doblan el metal a un ritmo incansable y constante que, pronto, se hace monótono. Y es que trabajar para otros da de comer, pero no sacia el apetito creativo. Con toda la experiencia del oficio en las manos se lanzan a diseñar un producto propio y único. Así nace el fútbolín RS2. Un diseño icónico que permite sacar el fútbolín del garaje para disfrutarlo en el salón, donde fluye la vida del hogar.

En 2006, la casualidad entra en juego cuando RS Barcelona y Vinçon, la tienda referente del diseño en Barcelona, se conocen y el RS2 se hace un hueco privilegiado en su escaparate. Ese encuentro fortuito les da la visibilidad y la proyección que necesitan para lanzarse a por más productos. Más sueños. Más lejos.

Así comienza todo: con un fútbolín. Pero no es un simple producto. No es solo un juego. Es toda una declaración de intenciones. Es su forma de entender el diseño y la esencia del *intense living*. Una manera de exaltar la belleza que reside en la vida y que nos invita a exprimir cada momento y saborearlo al máximo.

Eso es lo que venimos haciendo durante estos 15 años. Poner el alma y el oficio en todo lo que hacemos para compartir nuestra pasión por el diseño.



# Design & creation

Our passion for attention to detail can be traced back to our roots. It forms part and parcel of our craft. We've come to know the soul of our craft through the expertise acquired over the last 40 years in handling and shaping materials. That's the beauty of a job well done, finding that magical moment when the attention to detail and the precision of a machine join forces to achieve excellence. Working in close collaboration with local professionals and manufacturers, we produce iconic items. Made by us. With our own hands. At our own facilities. Designs made in Barcelona.

El amor por el detalle surge de nuestras raíces. Es innato al oficio. Las manos expertas del artesano y la experiencia tras más de 40 años tocando y moldeando materiales nos permite conocer su alma. Esa es la belleza del trabajo bien hecho. Encontrar ese momento mágico en el que el detalle artesanal de siempre y la precisión de la máquina se unen para dar lo mejor de sí y alcanzar la excelencia. Y así, trabajando en estrecha colaboración con profesionales y productores locales, fabricamos piezas icónicas. Hechas por nosotros mismos. Con nuestras propias manos. En nuestras propias instalaciones. Diseños hechos en Barcelona.

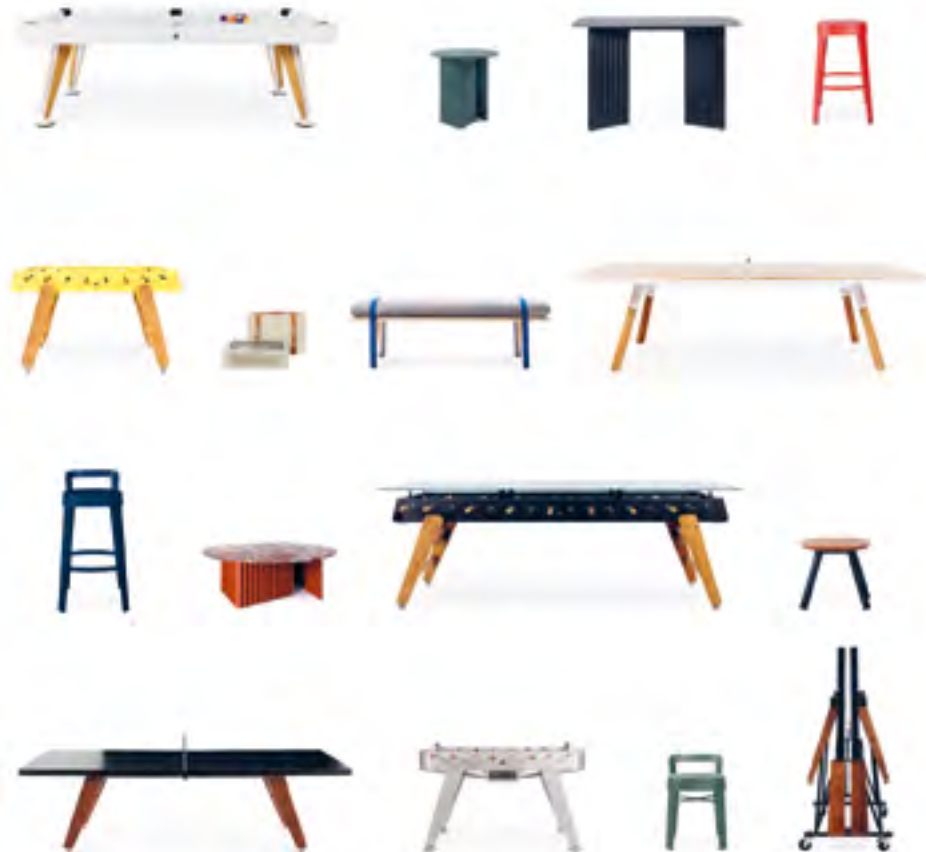

# Design & bespoke

The luxury of finesse. Of the details that make the ordinary extraordinary. Those little special features that make an item exclusive. We trust in the power of collaboration to get the best out of ourselves. You know what you want. We bring our experience and boldness, incorporating those special touches in order to make the item even more special and personal. We meet the needs and demands of your projects and —why not?—your whims. Let's make your item unique, proudly displaying bespoke design.

El lujo de la sutileza. De los detalles que hacen lo ordinario extraordinario. Son esas pequeñas peculiaridades las que convierten una pieza en exclusiva. Confiamos en el poder de la colaboración para sacar lo mejor de cada uno de nosotros. Tú sabes lo que quieres. Nosotros aportamos nuestra experiencia y confianza para incorporar esas pinceladas que lo harán, si cabe, más especial y personal. Y, así, atender a las necesidades y las exigencias de tus proyectos y, por qué no, de tus caprichos. Hagámoslo único y luce diseño a medida.

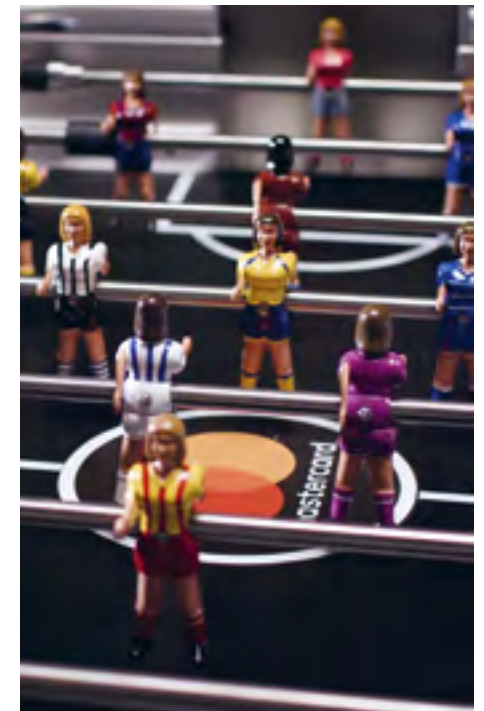



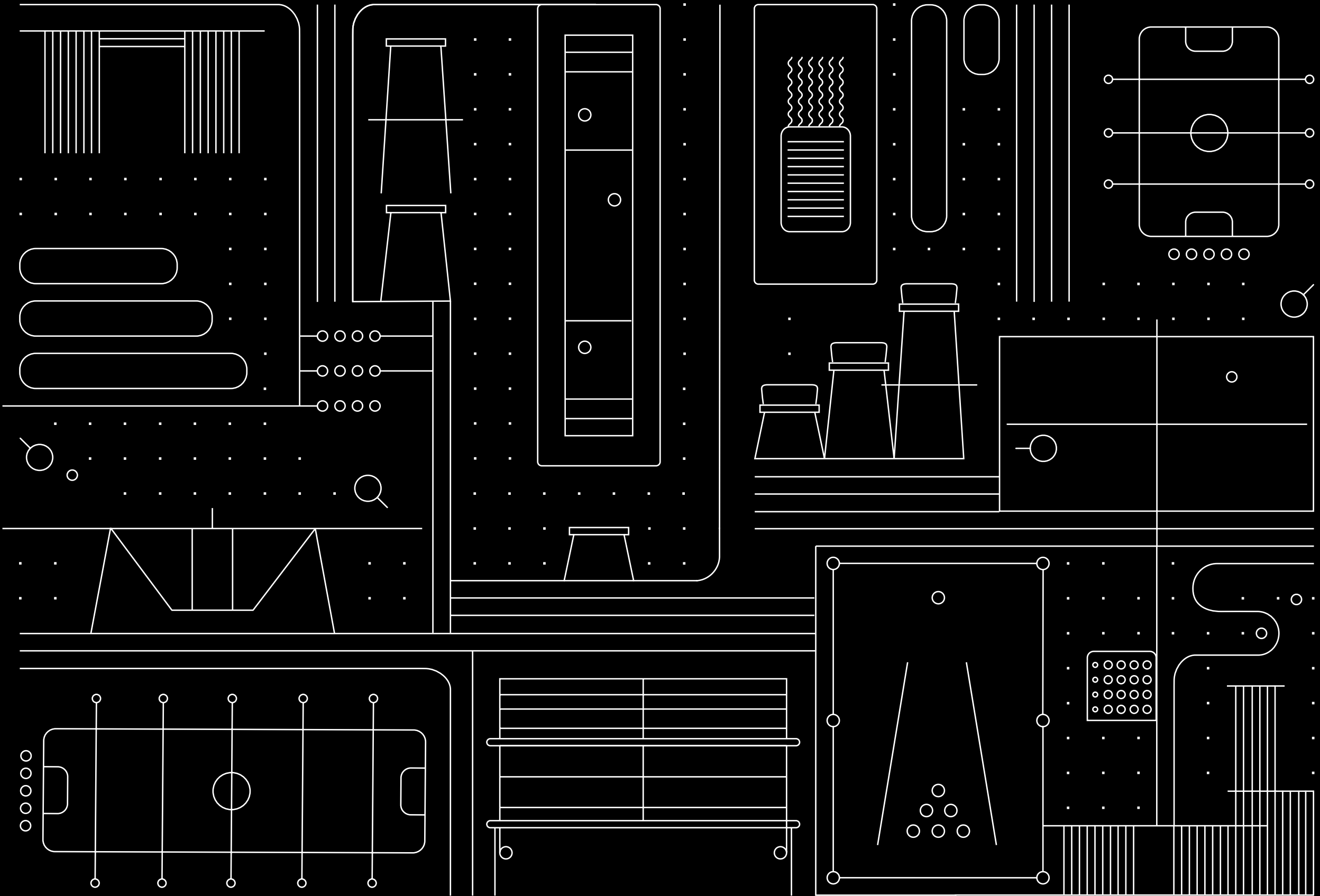

# Design & commitment

Well aware that our actions have consequences, we're committed to designing and manufacturing in a sustainable manner, focused on people's wellbeing and respect for the environment. We manufacture ethically, using high-quality, long-lasting and recyclable materials to create timeless products that transcend passing fads. We're committed to local manufacturing and processes that reduce our environmental impact. We do this with the simple goal of living in a kinder, more respectful manner, and in order to feel proud of the imprint we leave behind.

"Our products are 98% recyclable."

Conscientes de que nuestros actos tienen consecuencias, nos comprometemos a diseñar y fabricar de forma sostenible, enfocados en el bienestar de las personas y el respeto por el medio ambiente. Producimos de forma ética, con materiales de alta calidad y reciclables, con los que proponer piezas que perduran, trascendiendo las modas pasajeras y superando la barrera del tiempo. Apostamos por la producción local y la fabricación mediante procesos que reducen nuestro impacto ecológico. Con la simple pretensión de vivir de una forma más respetuosa y amable y sentirnos orgullosos de la huella que dejamos atrás.

"Nuestros productos son reciclables en un 98%"

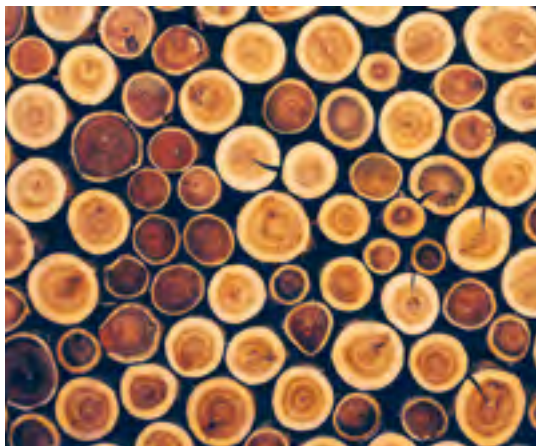

# Design & values

At RS Barcelona we create designs capable of transforming spaces, pieces that fill the atmosphere with their high aesthetic value and magnetism. They're experiences. They're unforgettable moments. They're our way of interpreting our surroundings. They reflect a set of values that define how we design, manufacture, work, share and live.

En RS Barcelona creamos diseños capaces de transformar espacios. Piezas que con su alto valor estético y su magnetismo llenan el ambiente. Son experiencias. Son momentos inolvidables. Son nuestro modo de interpretar lo que nos rodea. El reflejo de unos valores que definen nuestra forma de diseñar, fabricar, trabajar, compartir y vivir.

## Design

It's our essence. Design that goes beyond function and form, that inspires and excites, that captivates and wins over.

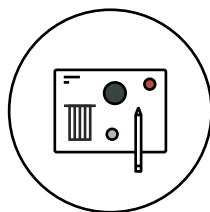

## Diseño

Es nuestra esencia. Diseño que va más allá de la función y la forma. Que inspira y emociona. Que seduce y conquista.

## Iconic

Authenticity that transcends trends and time, becoming exclusive and unique.

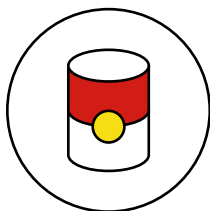

## Icónico

Autenticidad que trasciende a las tendencias y al tiempo y se convierte en exclusivo y único.

## Desire

Falling in love. Loving it to the point of needing it. Aspiration, a badge to be worn with pride.

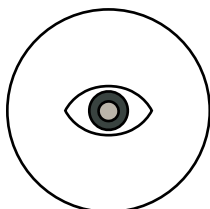

## Deseo

Enamorarse. Quererlo hasta el punto de necesitarlo. Aspiración, distinción de la que presumir.

## Quality

We're manufacturers. We control all the production processes. To ensure top quality down to the very last detail.

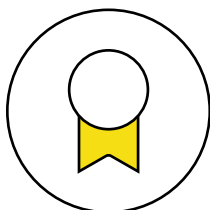

## Calidad

Somos fabricantes. Controlamos todos los procesos de producción. Para que la calidad sea máxima en cada detalle.

## Customer care

Quality beyond the product. Excellence in customer service and assistance, offering the perfect experience.

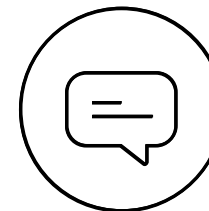

## Atención al cliente

Calidad más allá del producto. Excelencia en la atención y el servicio, haciendo sublime la experiencia.

## Customisation

Together we define your needs and expectations. And together we design a special product for you. No two are the same.

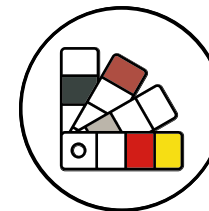

## Personalización

Juntos definimos tus necesidades y tus expectativas. Y juntos diseñamos un producto especial para ti. No hay dos iguales.

## Functionality

Design and functionality in perfect harmony. The versatility to adapt to emerging lifestyles and settings, whether simple or ostentatious.

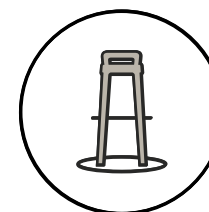

## Funcionalidad

Diseño y funcionalidad en perfecto equilibrio. Versatilidad que se adapta a estilos de vida y espacios dispares, tan sencillos como extravagantes.

## Sustainability and local production

There's no greater commitment to the planet than respectful manufacturing, so that our items can last a lifetime with you. That's our commitment: durability.

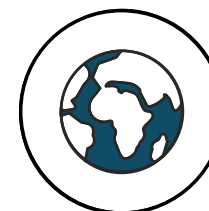

## Sostenibilidad y producción local

No hay mayor compromiso con el planeta que fabricar piezas de forma respetuosa y que estén a nuestro lado toda una vida. Ese es el nuestro: la durabilidad.

## Play

Play brings us closer. It allows us to be ourselves once we've hung up the uniform of our daily routine.

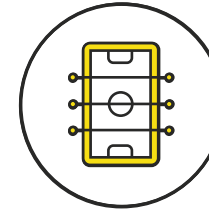

## Juego

El juego nos acerca. Nos une. Nos permite ser nosotros mismos una vez hemos colgado en el armario nuestro uniforme para la rutina.

## Sharing

There's no better feeling than sharing the good times with your loved ones. We aim to help you live those moments.

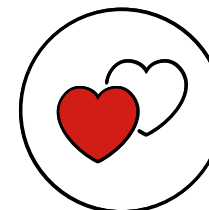

## Compartir

No hay mejor sensación que la de compartir los buenos momentos con los tuyos. Nuestro deseo, ayudarte a vivirlos.

# Design & designers

Working with designers means to be imbued by their artistic freedom and discovering new approaches to design and aesthetics, adding talent that brings experience and a fresh perspective to our universe.

Trabajar con diseñadores es empaparnos de su libertad artística y descubrir otras aproximaciones al diseño y la estética. Sumar talento que aporta experiencia y savia fresca a nuestro universo.



**Antoni Pallejà Office**



**Emiliana Design Studio**



**Rafael Rodríguez**



**Stone Designs**



**José Andrés**



**Mermelada Estudio**



**Yonoh**

# Product Fact Sheet Index



<b>Diagonal</b> Indoor Pool Table • Billar de Interior	124
<b>Diagonal</b> Outdoor Pool Table • Billar de Exterior	125
<b>Diagonal</b> Top Indoor • Sobre Interior	126
<b>Diagonal</b> Top Outdoor • Sobre Exterior	127
<b>Mou</b> Indoor Floor Cue Rack • Carrito de Interior	128
<b>Mou</b> Outdoor Floor Cue Rack • Carrito de Exterior	129
<b>You and Me</b> Indoor Ping Pong Table • Ping-Pong Interior	130
<b>You and Me</b> Outdoor Ping Pong Table • Ping-Pong Exterior	131
<b>You and Me</b> Bench • Banco	132
<b>RS Stationary</b> Ping Pong Table • Ping-Pong	134
<b>RS Folding</b> Ping Pong Table • Ping-Pong	135
<b>RS2</b> Football Table • Fútbolín	136
<b>RS2 Gold</b> Football Table • Fútbolín	137
<b>RS2 Dining</b> Football Table • Fútbolín Mesa	138
<b>RS3 Wood</b> Football Table • Fútbolín	139
<b>RS3 Wood Gold</b> Football Table • Fútbolín	140
<b>RS3 Wood Dining</b> Football Table • Fútbolín Mesa	141
<b>RS3</b> Football Table • Fútbolín	142
<b>RS4 Home</b> Football Table • Fútbolín	143
<b>RS Max</b> Football Table • Fútbolín	144
<b>RS Max Dining</b> Football Table • Fútbolín Mesa	145
<b>New</b> <b>Track</b> Shuffleboard • Shuffleboard	146
<b>New</b> <b>Track Dining</b> Shuffleboard • Shuffleboard	147
<b>Plec</b> Rectangular Occasional Table • Mesa de Centro Rectangular	148
<b>Plec</b> Round Occasional Table • Mesa de Centro Redonda	149
<b>Plec</b> Desk • Escritorio	150
<b>Plec</b> Pedestal • Pedestal	151
<b>B-Around</b> Table • Mesa	152
<b>New</b> <b>Crew</b> Stand • Gradas	156
<b>New</b> <b>Crew</b> Stand Accesories • Accesorios Grada	157
<b>Ombra</b> Stool • Taburete	158
<b>On The Road</b> Bench • Banco	160
<b>Mon Oncle</b> Barbecue • Barbacoa	161
<b>Wall Champions 1</b> Coat Hock • Colgador	162
<b>Wall Champions 4</b> Coat Rack • Colgador	163
<b>Make it extraordinary</b>	164

# Diagonal

Yonoh, 2018  
Indoor pool table  
Billar de interior



## Structure • Estructura



## Cloth • Tapete

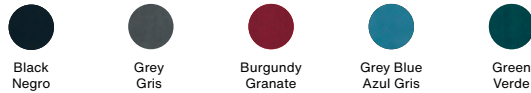

## Legs • Patas

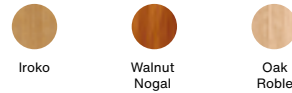

## Materials

Structure: Steel with micro textured polyester paint.  
Cloth: Simonis 860 90% worsted wool and 10% nylon.  
Board: 0.79 in | 20 mm thickness 1 piece fibre cement.  
Legs: FSC/PEFC certificated iroko wood.  
Cushion: K66 premium rubber cushion.

## Includes

Balls set (16 Aramith Premium Balls).  
2 Cues (Dufferin club cue Canadian Maple).  
1 triangle.  
12 Black Chalk Master.  
1 Table Brush.

## 7ft American • Americano 7pies

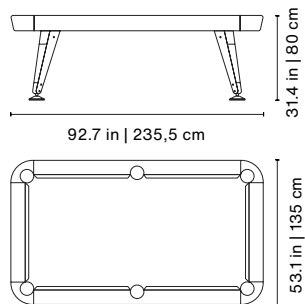

Playing area • Área de juego 78.7x39.4 in | 200x100 cm

Product weight • Peso del producto 439.8 lb | 224 kg

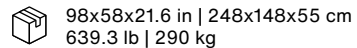

## 8ft American • Americano 8pies

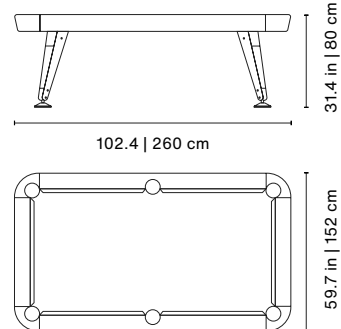

Playing area • Área de juego 88.2x44.1 in | 224x112 cm

Product weight • Peso del producto 529 lb | 240 kg

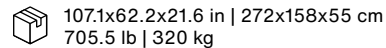

# Diagonal

Yonoh, 2020  
Covered outdoor use pool table  
Billar de exterior cubierto



## Structure • Estructura

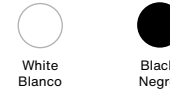

## Legs • Patas



## Cloth • Tapete

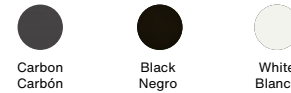

## Materials

Structure: Primer coated steel with micro textured powder coated polyester paint.  
Cloth: Sunbrella (100% acrylic).  
Board: 0.79 in | 20 mm thickness 1 piece fibre cement.  
Legs: FSC/PEFC certificated iroko wood.  
Cushion: K66 premium rubber cushion.

## Includes

Protective cover.  
Balls set (16 Aramith Premium Balls).  
2 Cues (Dufferin club cue Canadian Maple).  
1 triangle.  
12 Black Chalk Master.  
1 Table Brush.

## Materials

Estructura: Acero con imprimación y pintura poliéster en acabado micro texturado.  
Tapete: Sunbrella (100% acrílico).  
Tablero: 1 pieza de fibro cemento de 20 mm de espesor.  
Patas: Madera de iroko certificada FSC/PEFC.  
Cojinetes: Goma K66 premium.

## Incluye

Funda de protección.  
Set de bolas (16 bolas Aramith Premium).  
2 tacos (Dufferin club de arce canadiense).  
1 triángulo.  
12 tizas Black Master.  
1 cepillo para el tapete.

## 7ft American • Americano 7pies

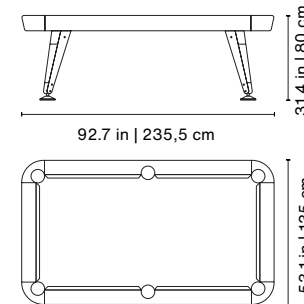

Playing area • Área de juego 78.7x39.4 in | 200x100 cm

Product weight • Peso del producto 439.8 lb | 224 kg

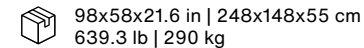

## 8ft American • Americano 8pies

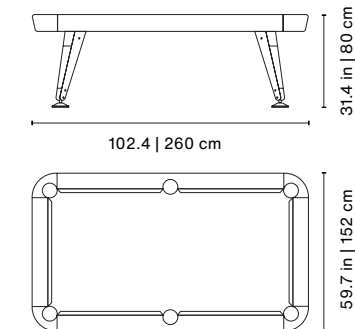

Playing area • Área de juego 88.2x44.1 in | 224x112 cm

Product weight • Peso del producto 529 lb | 240 kg

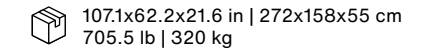

# Diagonal

**Yonoh, 2019**  
Indoor top  
Sobre mesa de interior



## Finishes • Acabados



Iroko

Walnut  
NogalOak  
Roble

## Materials

Cross-ply and FSC/PEFC certificated iroko wood, walnut or oak veneer.

It comes in three pieces.

## 7ft American • Americano 7pies

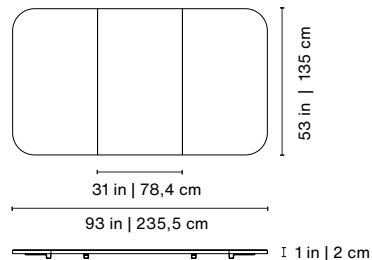

**Product weight • Peso del producto** 105.8 lb | 48 kg



57.8x35x9.8 in | 147x89x25 cm  
114.6 lb | 55 kg

## Materiales

Contrachapado en acabado madera de iroko certificada FSC/PEFC, nogal o roble.

Viene en tres piezas.

## 8ft American • Americano 8pies

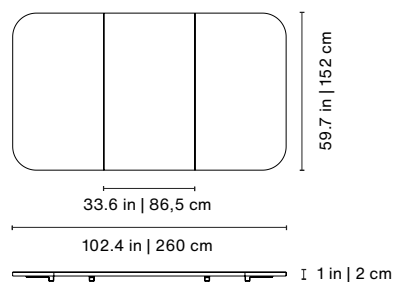

**Product weight • Peso del producto** 132.3 lb | 60 kg



63.4x37.4x10.2 in | 161x95x26 cm  
147.7 lb | 67 kg

# Diagonal

**Yonoh, 2020**  
Covered outdoor use pool table top  
Sobre mesa de exterior cubierto



## Finishes • Acabados

White  
BlancoBlack  
Negro

## Materials

HPL (white or black).

It comes in three pieces.

## 7ft American • Americano 7pies

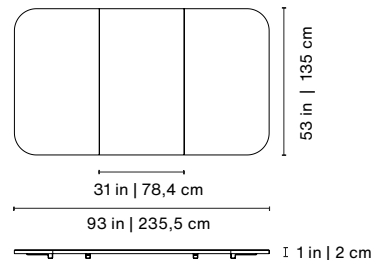

**Product weight • Peso del producto** 105.8 lb | 48 kg



57.8x35x9.8 in | 147x89x25 cm  
114.6 lb | 55 kg

## Materiales

HPL (blanco o negro)

Viene en tres piezas.

## 8ft American • Americano 8pies

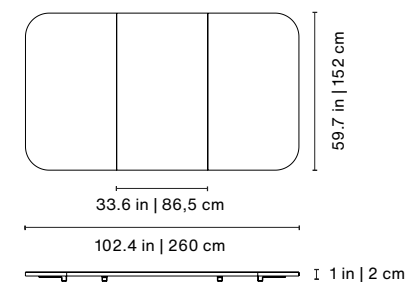

**Product weight • Peso del producto** 132.3 lb | 60 kg



63.4x37.4x10.2 in | 161x95x26 cm  
147.7 lb | 67 kg

# Mou

**Yonoh, 2019**  
Indoor floor cue rack  
Carrito de interior



## Structure • Estructura



White  
Blanco



Black  
Negro



Red  
Rojo



Blue  
Azul



Green  
Verde

## Trays • Bandejas



Iroko



Walnut  
Nogal



Oak  
Roble

## Materials

Structure: Steel with micro textured polyester paint.  
Trays: Croosply and iroko, walnut or oak veneer.

## Includes

Wheels.

**The Mou floor cue rack does not include the Diagonal accessories.** They come with the pool table.

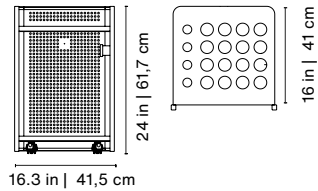

**Product weight • Peso del producto** 33 lb | 15 kg



18.9x17.3x26.4 in | 48x44x67 cm  
35.5 lb | 16 kg

# Mou

**Yonoh, 2020**  
Covered outdoor use floor cue rack  
Carrito de exterior cubierto



## Structure • Estructura



White  
Blanco



Black  
Negro

## Materials

Structure: Primer coated steel with micro textured powder coated polyester paint.  
Trays: HPL (white or black).  
Wooden details: Iroko wood.

## Includes

Wheels.  
Protective cover.

**The Mou floor cue rack does not include the Diagonal accessories.** They come with the pool table.

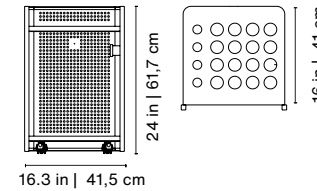

**Product weight • Peso del producto** 33 lb | 15 kg



18.9x17.3x26.4 in | 48x44x67 cm  
35.5 lb | 16 kg

## Materials

Estructura: Acero con imprimación y pintura poliéster en acabado micro texturado.  
Bandejas: HPL (blanco o negro).  
Detalles madera: Iroko.

## Incluye

Ruedas.  
Funda de protección.

**El carrito no incluye los accesorios del Diagonal.** Estos vienen con la mesa de billar.



# You and Me

Antoni Pallejà Office, 2013  
Indoor ping pong table  
Ping-pong interior



## Structure • Estructura



White  
Blanco



Black  
Negro

## Materials

Structure: Steel with cataphoretic coating process and micro textured powder coated polyester paint.

Top: Walnut or oak wood.

Legs: Walnut or oak wood.

Net: Coated polyester fabric.

## Includes

Net.  
Paddles set (2 units).  
Balls set (6 units).

## Top and Legs • Sobre y Patas



Walnut  
Nogal



Oak  
Roble

## Materiales

Estructura: Acero con cataforesis y pintura poliéster con acabado micro texturado.

Sobre: Madera de nogal o roble.

Patas: Madera de nogal o roble.

Red: Poliéster.

## Incluye

Red.  
Set de palas (2 unidades).  
Set de bolas (6 unidades).

## Standard

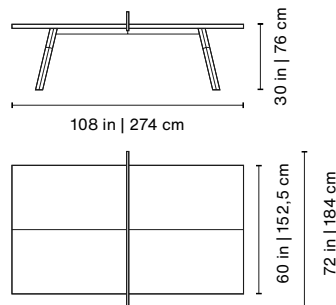

**Product weight • Peso del producto**  
260 lb | 118 kg



64.6x59.8x20.7 in |  
164x152x53 cm  
330.7 lb | 150 kg

## 220 Medium • 220 Mediana

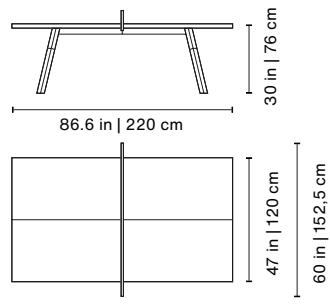

**Product weight • Peso del producto**  
220.5 lb | 100 kg



88.6x52.6x19.7 in |  
225x134,2x50 cm  
265 lb | 120 kg

## 180 Small • 180 Pequeña

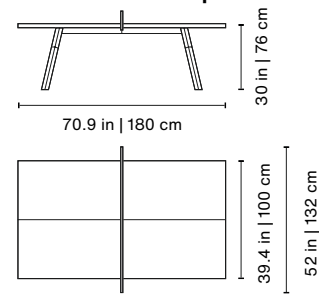

**Product weight • Peso del producto**  
165.3 lb | 75 kg



74.8x46x20.8 in |  
190x117x53 cm  
220.5 lb | 100 kg

You and Me  
Collection

# You and Me

Antoni Pallejà Office, 2013  
Outdoor ping pong table  
Ping-pong exterior



Black finish for covered outdoor use  
Color negro para uso en exterior cubierto



## Structure and Top • Estructura y Sobre



White  
Blanco



Black  
Negro

## Materials

Structure: Steel with cataphoretic coating process and micro textured powder coated polyester paint.

Top: HPL (white or black).

Legs: FSC/PEFC certified iroko wood.

Net: Coated polyester fabric.

## Includes

Net.  
Paddles set (2 units).  
Balls set (6 units).

## Legs • Patas



Iroko

## Materiales

Estructura: Acero con cataforesis y pintura poliéster en acabado micro texturado.

Sobre: HPL (blanco o negro).

Patas: Madera de iroko certificada FSC/PEFC.

Red: Poliéster.

## Incluye

Red.  
Set de palas (2 unidades).  
Set de bolas (6 unidades).

## Standard

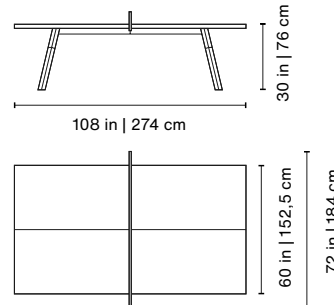

**Product weight • Peso del producto**  
238 lb | 108 kg



64.6x59.8x20.7 in |  
164x152x53 cm  
308.5 lb | 140 kg

## 220 Medium • 220 Mediana

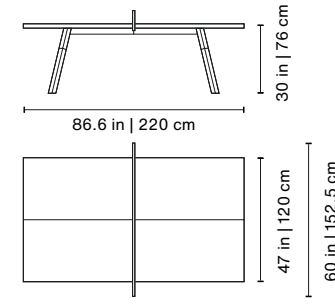

**Product weight • Peso del producto**  
165 lb | 75 kg



88.6x52.6x19.7 in |  
225x134,2x50 cm  
220.5 lb | 100 kg

## 180 Small • 180 Pequeña

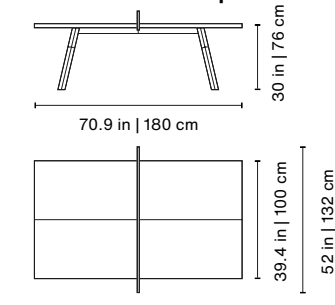

**Product weight • Peso del producto**  
143.3 lb | 65 kg



74.8x46x20.8 in |  
190x117x53 cm  
165 lb | 75 kg

You and Me  
Collection

# You and Me

Antoni Pallejà Office, 2015  
Bench  
Banco



### Structure • Estructura



White  
Blanco



Black  
Negro

### Materials

Structure: Steel with cathaphoretic coating process and micro textured powder coated polyester paint.  
Seat: FSC/PEFC certificated iroko wood or oak wood (oak finish only for indoor use).

### Product options

Ask for custom sizes.

### 285 Bench • Banco 285

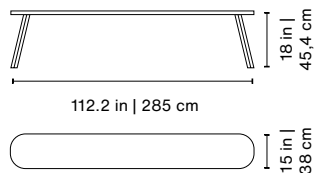

Product weight • Peso del producto 83.7 lb | 38 kg

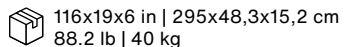

### 180 Bench • Banco 180

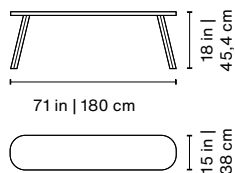

Product weight • Peso del producto 55 lb | 25 kg

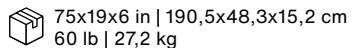

### Seat • Asiento



Iroko



Oak  
Roble

### Materiales

Estructura: Acero con cataforesis y pintura poliéster en acabado micro texturado.  
Asiento: Madera de iroko certificada FSC/PEFC o roble (acabado roble solo para uso interior).

### Opciones

Pregúntanos por otras medidas.

### 220 Bench • Banco 220

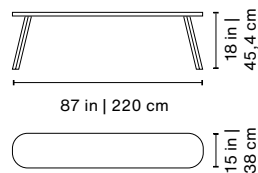

Product weight • Peso del producto 70 lb | 31,4 kg

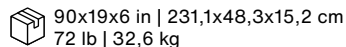

### 160 Bench • Banco 160

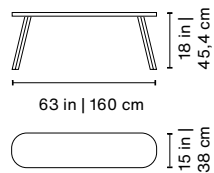

Product weight • Peso del producto 49 lb | 22,2 kg

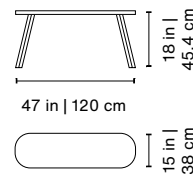
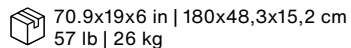

Product weight • Peso del producto 38 lb | 17 kg

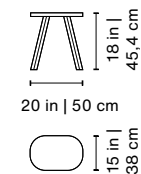
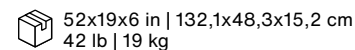

Product weight • Peso del producto 17.8 lb | 8 kg

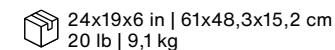

### Cushions • Cojines



### Finishes • Acabados



White  
Blanco



Dark Taupe

### Materials

Upholstery: Natté from Sunbrella (100% acrylic).

### Materiales

Tapizado: Natté de Sunbrella (100% acrílico).

### 285

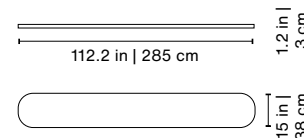

Product weight • Peso del producto 5.8 lb | 2,6 kg

### 220

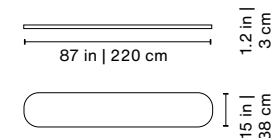

Product weight • Peso del producto 4.4 lb | 2 kg

### 180

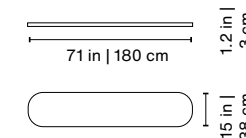

Product weight • Peso del producto 3.6 lb | 1,6 kg

### 160

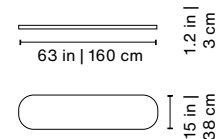

Product weight • Peso del producto 3.1 lb | 1,4 kg

### 120

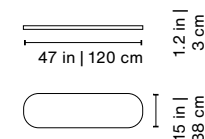

Product weight • Peso del producto 2.4 lb | 1 kg

### 50

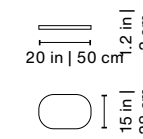

Product weight • Peso del producto 1 lb | 0,45 kg

You and Me  
Collection

# RS Stationary

Rafael Rodríguez, 2017

Ping pong table  
Ping-pong



Black finish for covered outdoor use  
Color negro para uso en exterior cubierto



## Structure and Top • Estructura y Sobre



White  
Blanco



Black  
Negro

## Materials

Structure: Steel with cataphoretic coating process and micro textured powder coated polyester paint.

Top: HPL (white or black).

Legs: FSC/PEFC certificated iroko wood.

Net: Coated polyester fabric.

## Includes

Net.

Paddles set (2 units).

Balls set (6 units).

Storage bag.

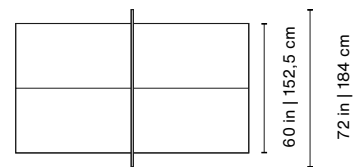
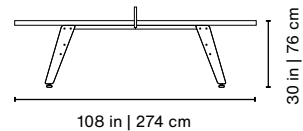

Product weight • Peso del producto 264.5 lb | 120 kg



68x70x21 in | 172,7x154,9x53,3 cm  
330.7 lb | 150 kg

# RS Folding

Rafael Rodríguez, 2017

Ping pong table  
Ping-pong



Black finish for covered outdoor use  
Color negro para uso en exterior cubierto



## Structure and Top • Estructura y Sobre



White  
Blanco



Black  
Negro

## Materials

Structure: Steel with cataphoretic coating process and micro textured powder coated polyester paint.

Top: HPL (white or black).

Legs: FSC/PEFC certificated iroko wood.

Net: Coated polyester fabric.

## Includes

Net.

Paddles set (2 units).

Balls set (6 units).

Storage bag.

## It comes assembled.

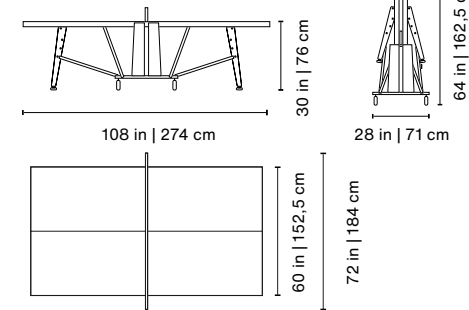

Product weight • Peso del producto 286.6 lb | 130 kg



68x32x73 in | 172,7x81,3x185,4 cm  
330.7 lb | 150 kg

## Materials

Estructura: Acero con cataforesis y pintura poliéster en acabado micro texturado.

Sobre: HPL (blanco o negro).

Patas: Madera de iroko certificada FSC/PEFC.

Red: Poliéster.

## Incluye

Red.

Set de palas (2 unidades).

Set de bolas (6 unidades).

Bolsa de almacenamiento.

## Se entrega montado.

# RS2

Rafael Rodríguez, 2006  
Football table  
Futbolín



## Indoor • Interior

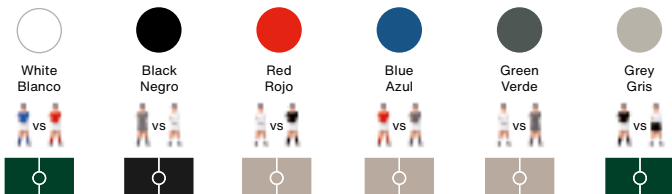

## Outdoor • Exterior

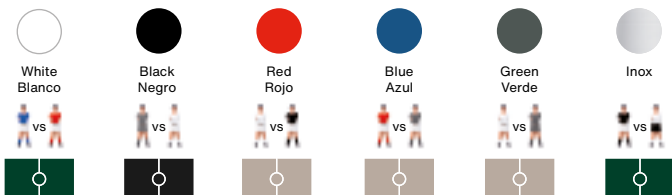

### Materials

Outdoor Inox finish: Shot blasted stainless steel lacquered.  
Outdoor RAL colour finish: Stainless steel and micro textured powder coated polyester paint.  
Indoor RAL colour finish: Steel and micro textured powder coated polyester paint.  
Field: HPL (green, cream or black).  
Players: Cast aluminium.  
Handles: FSC/PEFC certificated iroko wood.

### Includes

Balls set (7 units).  
2 extra players (1 per team).

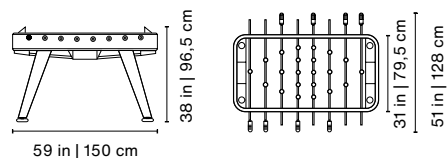

**Product weight • Peso del producto** 196.2 lb | 89 kg

63x53x22 in | 160x134,6x55,9 cm  
266.8 lb | 121 kg

# RS2 Gold

Rafael Rodríguez, 2016  
Football table  
Futbolín



## Colours • Colores

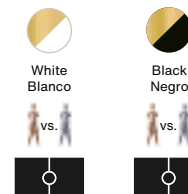

### Materials

Structure: Stainless steel and micro textured powder coated polyester paint.  
Field: HPL (black).  
Players: Cast aluminium in gold and silver chrome plating.  
Handles: Wood with polyester paint.  
Gold chrome plating bearing: The score counter, ball bearing, screws and other small pieces.

### Includes

Balls set (7 units).  
2 extra players (1 per team).

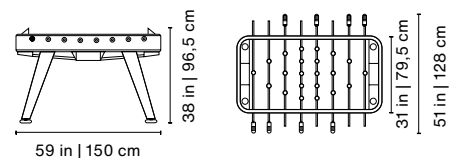

**Product weight • Peso del producto** 196.2 lb | 89 kg

63x53x22 in | 160x134,6x55,9 cm  
266.8 lb | 121 kg

### Materiales

Estructura: Acero inoxidable y pintura poliéster con acabado micro texturado.  
Campo: HPL (negro).  
Jugadores: Aluminio fundido cromado en oro y plata.  
Mangos: Madera y pintura poliéster.  
Piezas cromadas en baño de oro: Los cuentagoles, cojinetes, tornillos y algunas pequeñas piezas.

### Incluye

Set de bolas (7 unidades).  
2 jugadores extra (1 por equipo).

# RS2 Dining

José Andrés & Rafael Rodríguez, 2014  
Football dining table  
Futbolín mesa



### Indoor • Interior

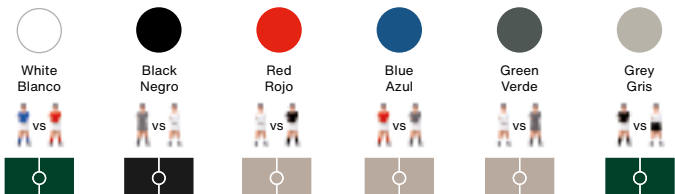

### Outdoor • Exterior

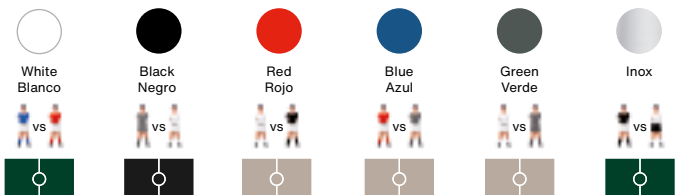

### Materials

Outdoor Inox finish: Shot blasted stainless steel lacquered.  
Outdoor RAL colour finish: Stainless steel and micro textured powder coated polyester paint.  
Indoor RAL colour finish: Steel and micro textured powder coated polyester paint.  
Glass: 0.4 in | 1 cm tempered glass.  
Field: HPL (green, cream or black).  
Players: Cast aluminium.  
Handles: FSC/PEFC certificated iroko wood.

### Materiales

Acabado Inox: Acero inoxidable granallado y lacado.  
Acabado color RAL exterior: Acero inoxidable y pintura poliéster con acabado micro texturado.  
Acabado color RAL interior: Acero y pintura poliéster con acabado micro texturado.  
Cristal: Vidrio templado de 1 cm de espesor.  
Campo: HPL (verde, crema o negro).  
Jugadores: Aluminio fundido.  
Mangos: Madera de iroko certificada FSC/PEFC.

### Includes

Balls set (7 units).  
2 extra players (1 per team).

### Incluye

Set de bolas (7 unidades).  
2 jugadores extra (1 por equipo).

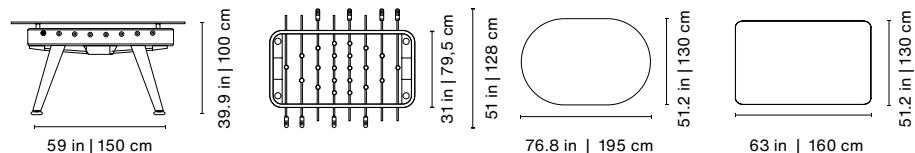

Product weight • Peso del producto 324 lb | 147 kg

80.3x59x33.3 in | 204x152x77 cm  
557.8 lb | 253 kg

# RS3 Wood

Rafael Rodríguez, 2012  
Football table  
Futbolín



New Colours

### Colours • Colores

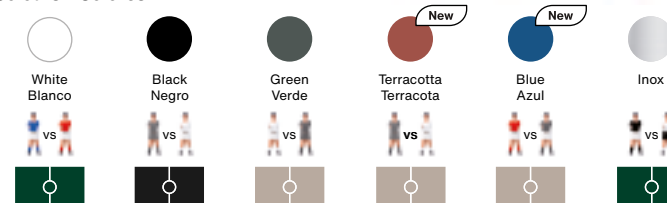

### Materials

Inox finish: Shot blasted stainless steel lacquered.  
RAL colour finish: Steel with cataphoretic coating process and micro textured powder coated polyester paint.  
Field: HPL (green, cream or black).  
Legs: FSC/PEFC certificated iroko wood.  
Players: Cast aluminium.  
Handles: FSC/PEFC certificated iroko wood.

### Materiales

Acabado Inox: Acero inoxidable granallado y lacado.  
Acabado color RAL: Acero con cataforesis y pintura poliéster con acabado micro texturado.  
Campo: HPL (verde, crema o negro).  
Patatas: Madera de iroko certificada FSC/PEFC.  
Jugadores: Aluminio fundido.  
Mangos: Madera de iroko certificada FSC/PEFC.

### Includes

Balls set (7 units).  
2 extra players (1 per team).

### Incluye

Set de bolas (7 unidades).  
2 jugadores extra (1 por equipo).

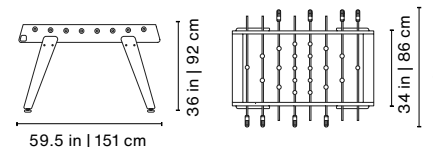

Product weight • Peso del producto 172 lb | 78 kg

63x53x22 in | 160x134,6x55,9 cm  
242.5 lb | 110 kg

# RS3 Wood Gold

Rafael Rodríguez, 2016

Football table  
Futbolín



## Colours • Colores



Black  
Negro



## Materials

Structure: Steel with cataphoretic coating process and micro textured powder coated polyester paint.

Field: HPL (black).

Legs: Dark stained FSC/PEFC certificated iroko wood.

Players: Cast aluminium in gold and silver chrome plating.

Handles: Dark stained FSC/PEFC certificated iroko wood.

Gold chrome plating bearing: The score counter, ball bearing, screws and other small pieces.

## Includes

Balls set (7 units).

2 extra players (1 per team).

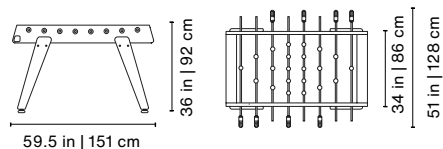

Product weight • Peso del producto 172 lb | 78 kg

63x53x22 in | 160x134,6x55,9 cm  
242.5 lb | 110 kg

## Materiales

Estructura: Acero inoxidable y pintura poliéster con acabado micro texturado.

Campo: HPL (negro).

Patatas: Madera de iroko certificada FSC/PEFC teñida de oscuro.

Jugadores: Aluminio fundido cromado en oro y plata.

Mangos: Madera de iroko certificada FSC/PEFC teñida de oscuro.

Piezas cromadas en baño de oro: Los cuentagoles, cojinetes, tornillos y algunas pequeñas piezas.

## Incluye

Set de bolas (7 unidades).

2 jugadores extra (1 por equipo).

# RS3 Wood Dining

New Colours

Rafael Rodríguez, 2020

Football dining table  
Futbolín mesa



## Colours • Colores



White  
Blanco



Black  
Negro



Green  
Verde



Terracotta  
Terracota



Blue  
Azul



Inox



## Materials

Inox finish: Shot blasted stainless steel lacquered.

RAL colour finish: Steel with cataphoretic coating process and micro textured powder coated polyester paint.

Glass: 0.4 in | 1 cm tempered glass.

Field: HPL (green, cream or black).

Legs: FSC/PEFC certificated iroko wood.

Players: Cast aluminium.

Handles: FSC/PEFC certificated iroko wood.

## Includes

Balls set (7 units).

2 extra players (1 per team).

## Materiales

Acabado Inox: Acero inoxidable granallado y lacado.

Acabado color RAL exterior: Acero inoxidable y pintura poliéster con acabado micro texturado.

Cristal: Vidrio templado de 1 cm de espesor.

Campo: HPL (verde, crema o negro).

Patatas: Madera de iroko certificada FSC/PEFC.

Jugadores: Aluminio fundido.

Mangos: Madera de iroko certificada FSC/PEFC.

## Incluye

Set de bolas (7 unidades).

2 jugadores extra (1 por equipo).

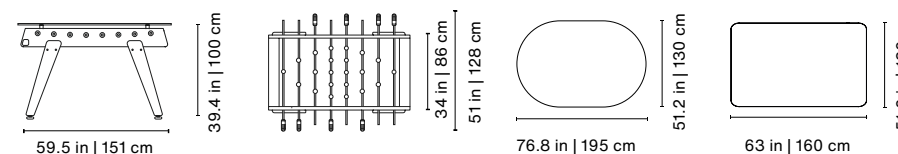

Product weight • Peso del producto 295.4 lb | 134 kg

80.3x59x33.3 in | 204x152x77 cm  
530.2 lb | 240,5 kg

# RS3

Rafael Rodríguez, 2011  
Football table  
Futbolín



New Colour

## Colours • Colores

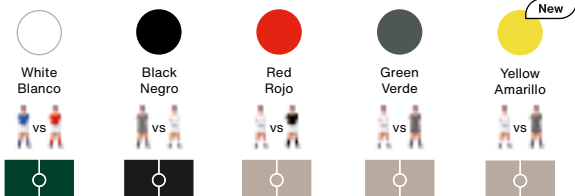

## Materials

Structure: Steel with cathoretic coating process and micro textured powder coated polyester paint.

Field: HPL (green, cream or black).

Players: Cast aluminium.

Handles: FSC/PEFC certificated iroko wood.

## Includes

Balls set (7 units).

2 extra players (1 per team).

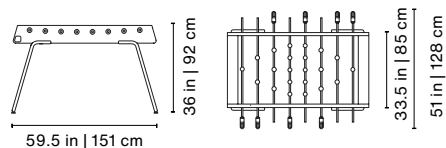

Product weight • Peso del producto 145.5 lb | 66 kg

63x53x22 in | 160x134,6x55,9 cm  
216 lb | 98 kg

## Materiales

Estructura: Acero con cataforesis y pintura poliéster con acabado micro texturado.

Campo: HPL (verde, crema o negro).

Jugadores: Aluminio fundido.

Mangos: Madera de iroko certificada FSC/PEFC.

## Incluye

Set de bolas (7 unidades).

2 jugadores extra (1 por equipo).

# RS4 Home

Rafael Rodríguez, 2020  
Football table  
Futbolín



## Colours • Colores

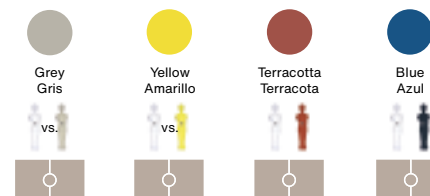

## Materials

Structure: Steel with cathoretic coating process and micro textured powder coated polyester paint.

Field: HPL (grey).

Legs: FSC/PEFC certificated iroko wood.

Players: Cast aluminium.

Handles: FSC/PEFC certificated iroko wood.

## Includes

Balls set (7 units).

2 extra players (1 per team).

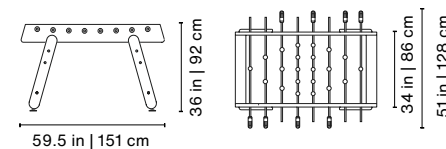

Product weight • Peso del producto 136.7 lb | 62 kg

63x35.4x15 in | 160x90x38 cm  
202.8 lb | 92 kg

## Materiales

Estructura: Acero con cataforesis y pintura poliéster en acabado micro texturado.

Campo: HPL (gris).

Patas: Madera de iroko certificada FSC/PEFC.

Jugadores: Aluminio fundido.

Mangos: Madera de iroko certificada FSC/PEFC.

## Incluye

Set de bolas (7 unidades).

2 jugadores extra (1 por equipo).



Easy assembly, for doing it yourself with no need of a professional team.  
Fácil montaje sin necesidad de un equipo de profesionales.

# RS Max

Rafael Rodríguez, 2020  
Football table  
Futbolín



New Colours

UP TO  
8  
PLAYERS

## Colours • Colores

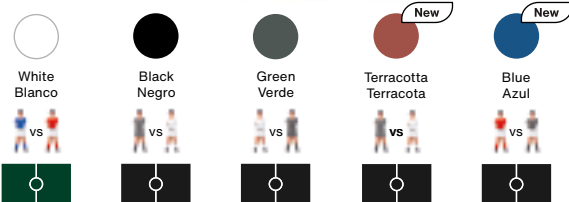

## Materials

Structure: Steel with cataphoretic coating process and micro textured powder coated polyester paint.  
Field: HPL (green or black).  
Legs: FSC/PEFC certificated iroko wood.  
Players: Cast aluminium.  
Handles: FSC/PEFC certificated iroko wood.

## Includes

Balls set (7 units).  
4 extra players (2 per team).

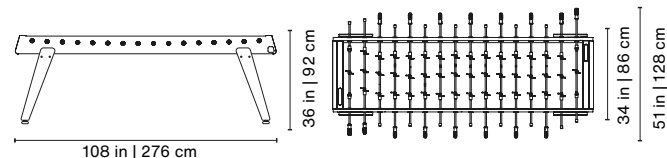

Product weight • Peso del producto 275.6 lb | 125 kg

113.4x52x20.9 in | 288x132x53 cm  
445.3 lb | 202 kg

# RS Max Dining

Rafael Rodríguez, 2020  
Football dining table  
Futbolín mesa



New Colours

UP TO  
8  
PLAYERS

## Colours • Colores

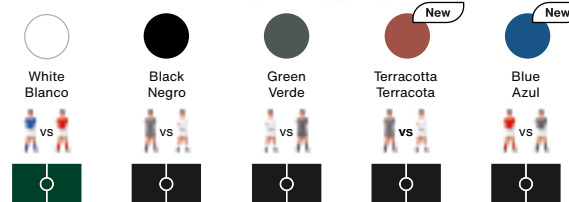

## Materials

Structure: Steel with cataphoretic coating process and micro textured powder coated polyester paint.  
Glass: 0.4 in | 1 cm templated glass.  
Field: HPL (green or black).  
Legs: FSC/PEFC certificated iroko wood.  
Players: Cast aluminium.  
Handles: FSC/PEFC certificated iroko wood.

## Includes

Balls set (7 units).  
4 extra players (2 per team).

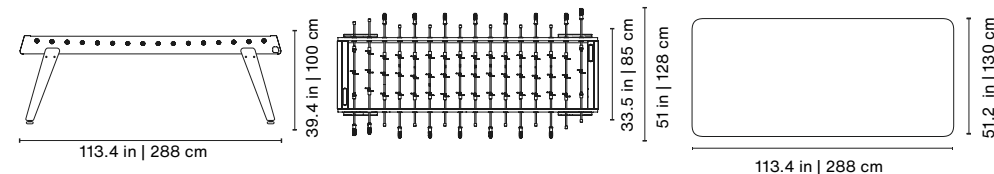

Product weight • Peso del producto 496 lb | 225 kg

116.1x55.1x30.1 in | 295x140x77 cm  
690 lb | 313 kg

## Materiales

Estructura: Acero con cataforesis y pintura poliéster con acabado micro texturado.  
Cristal: Vidrio templado de 1 cm de espesor.  
Campo: HPL (verde o negro).  
Patatas: Madera de iroko certificada FSC/PEFC.  
Jugadores: Aluminio fundido.  
Mangos: Madera de iroko certificada FSC/PEFC.

## Incluye

Set de bolas (7 unidades).  
4 jugadores extra (2 por equipo).



# Track

Rafael Rodríguez, 2023  
Shuffleboard

 Covered outdoor use  
Uso en exterior cubierto



New

### Structure • Estructura



### Inner lining • Revestimiento interior



### Legs • Patas



### Materials

Structure: Steel with cathophoretic coating process and micro textured powder coated polyester paint.

Playing field: Steel with cataphoresis and bicomponent epoxy resin.

Legs: FSC/PEFC certificated iroko wood.

Inner lining: Textfel Eco 9 100% PET (60% recycled).

### Includes

Puck set (8 units).  
450g shuffleboard powder.

### 12ft · 12pies

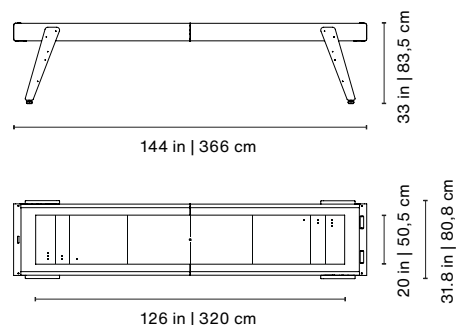

Product weight • Peso del producto 397 lb | 180 kg

### 9ft · 9pies

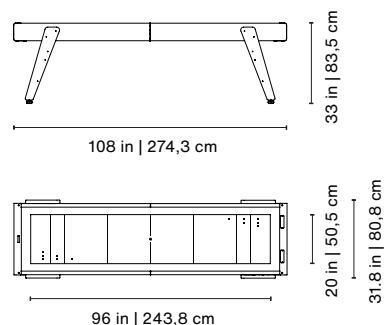

Product weight • Peso del producto 298 lb | 135 kg

### Materiales

Estructura: Acero con cataforesis y pintura poliéster con acabado micro texturado.

Campo de juego: Acero con cataforesis y resina epoxi bicomponente.

Patatas: Madera de iroko certificada FSC/PEFC.

Revestimiento interior: Textfel Eco 9 100% PET (60% reciclado).

### Incluye.

Set de puks (8 unidades).  
450 gr de cera en polvo para shuffleboard.

# Track Dining

Rafael Rodríguez, 2023  
Shuffleboard dining table  
Shuffleboard mesa

 Covered outdoor use  
Uso en exterior cubierto



New

### Structure • Estructura



### Inner lining • Revestimiento interior



### Legs • Patas



### Materials

Structure: Steel with cathophoretic coating process and micro textured powder coated polyester paint.

Glass: 0.4 in | 1 cm templated glass.

Playing field: Steel with cataphoresis and bicomponent epoxy resin.

Legs: FSC/PEFC certificated iroko wood.

Inner lining: Textfel Eco 9 100% PET (60% recycled).

### Includes

Puck set (8 units).  
450g shuffleboard powder.

### Materiales

Estructura: Acero con cataforesis y pintura poliéster con acabado micro texturado.

Cristal: Vidrio templado de 1 cm de espesor.

Campo de juego: Acero con cataforesis y resina epoxi bicomponente.

Patatas: Madera de iroko certificada FSC/PEFC.

Revestimiento interior: Textfel Eco 9 100% PET (60% reciclado).

### Incluye.

Set de puks (8 unidades).  
450 gr de cera en polvo para shuffleboard.

### 12ft · 12pies

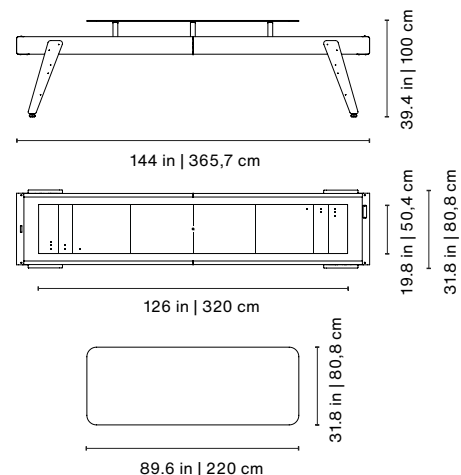

Product weight • Peso del producto 584 lb | 265 kg

### 9ft · 9pies

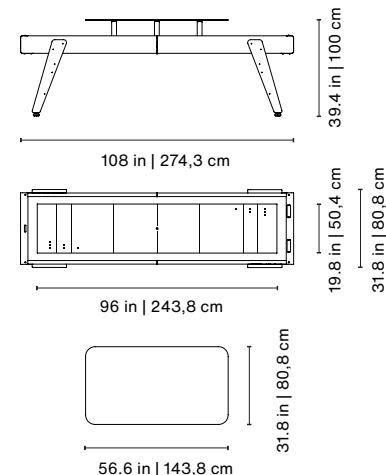

Product weight • Peso del producto 430 lb | 195 kg

# Plec

Antoni Pallejà Office, 2017  
Rectangular occasional table  
Mesa de centro rectangular



Plec  
Collection

## Steel • Acero



White  
Blanco



Black  
Negro



Terracotta  
Terracota



Green  
Verde

## Marble • Mármol



White Carrara



Black Marquina



Red Francia



Green Aver

## Materials

Steel with cathaphoretic coating process and micro textured powder coated polyester paint.  
Top: Steel or marble.

All the table sizes include levelers.

## Product options

Steel legs and top or steel legs and marble top.

## Materiales

Acero con cataforesis y pintura poliéster en acabado micro texturado.  
Sobre: Acero o mármol.

Todas las medidas incluyen nivelador.

## Opciones

Patas y sobre de acero o patas de acero y sobre de mármol.

## Large • Grande

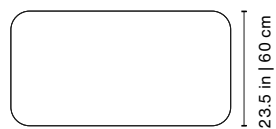
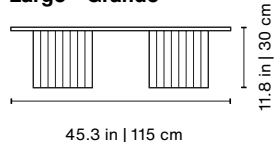

## Medium • Mediana

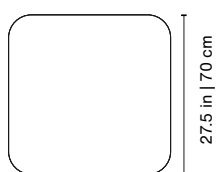
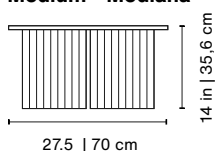

## Small • Pequeña

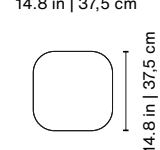
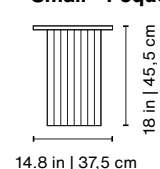

## Steel • Acero

Product weight • Peso del producto  
52.5 lb | 23,8 kg



47.2x26x19.7 in |  
120x66x50 cm  
55.12 lb | 25 kg

## Steel • Acero

Product weight • Peso del producto  
45.2 lb | 20,5 kg



29.5x29.5x15.4 in |  
75x75x39 cm  
48,5 lb | 22 kg

## Steel • Acero

Product weight • Peso del producto  
18.3 lb | 8,3 kg



16.5x16.5x20.1 in |  
42x42x51 cm  
22 lb | 10 kg

## Marble • Mármol

Product weight • Peso del producto  
92.6 lb | 42 kg



49.2x27.6x19.7 in |  
125x70x50 cm  
152.1 lb | 69 kg

## Marble • Mármol

Product weight • Peso del producto  
75 lb | 34 kg



31.5x31.5x22.4 in |  
80x80x57 cm  
120.2 lb | 54,5 kg

## Marble • Mármol

Product weight • Peso del producto  
25.6 lb | 11,6 kg



17.7x17.7x19.7 in |  
45x45x50 cm  
35.3 lb | 16 kg

# Plec

Antoni Pallejà Office, 2020  
Round occasional table  
Mesa de centro redonda



Plec  
Collection

## Steel • Acero



White  
Blanco



Black  
Negro



Terracotta  
Terracota



Green  
Verde

## Marble • Mármol



White Carrara



Black Marquina



Red Francia



Green Aver

## Materials

Steel with cathaphoretic coating process and micro textured powder coated polyester pain.  
Top: Steel or marble.

All the table sizes include levelers.

## Product options

Steel legs and top or steel legs and marble top.

## Materiales

Acero con cataforesis y pintura poliéster en acabado micro texturado.  
Sobre: Acero o mármol.

Todas las medidas incluyen nivelador.

## Opciones

Patas y sobre de acero o patas de acero y sobre de mármol.

## Large • Grande

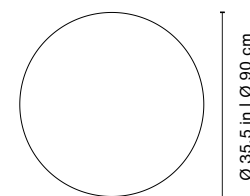

## Steel • Acero

Product weight • Peso del producto  
44 lb | 29 kg



37.4x37.4x18.5 in |  
95x95x47 cm  
81.6 lb | 37 kg

## Marble • Mármol

Product weight • Peso del producto  
114.6 lb | 52 kg



39.8x39.8x21.8 in |  
101x101x55,5 cm  
163.1 lb | 74 kg

## Small • Pequeña

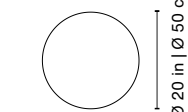
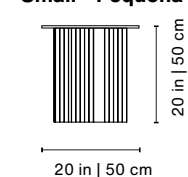

## Steel • Acero

Product weight • Peso del producto  
30.9 lb | 14 kg



21.7x21.7x21.7 in |  
55x55x55 cm  
33 lb | 15 kg

## Marble • Mármol

Product weight • Peso del producto  
48.5 lb | 22 kg



26x24x22 in |  
66x61x56 cm  
61.7 lb | 28 kg

# Plec

Antoni Pallejà Office, 2020

Desk  
Escritorio



Plec  
Collection

## Steel • Acero



White  
Blanco



Black  
Negro



Terracotta  
Terracota



Green  
Verde

## Marble • Mármol



White Carrara



Black Marquina



Red Francia



Green Aver

### Materials

Steel with cathaphoretic coating process and micro textured powder coated polyester paint.  
Top: Steel or marble.

Include levelers.

### Product options

Steel legs and top or steel legs and marble top.

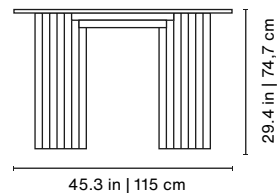

## Steel • Acero

### Product weight • Peso del producto

90.4 lb | 41 kg



47.2x26x36.6 in |  
120x66x93 cm  
108 lb | 49 kg

## Marble • Mármol

### Product weight • Peso del producto

134.5 lb | 61 kg



49.2x27.5x38 in |  
125x70x96,5 cm  
185.2 lb | 84 kg

# Plec

Antoni Pallejà Office, 2020

Pedestal



Plec  
Collection

## Steel • Acero



White  
Blanco



Black  
Negro



Terracotta  
Terracota



Green  
Verde

### Materials

Steel with cathaphoretic coating process and micro textured powder coated polyester paint.  
Top: Steel.

Include levelers.

### Materiales

Acero con cataforesis y pintura poliéster en acabado micro texturado.  
Sobre: Acero.

Incluye nivelador.

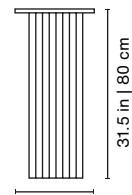

14.8 in | 37,5 cm

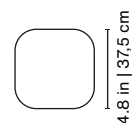

14.8 in | 37,5 cm

### Product weight • Peso del producto

29.8 lb | 13,5 kg



16.5x16.5x33.8 in |  
42x42x86 cm  
32 lb | 14,5 kg

# B-Around

Antoni Pallejà Office, 2015  
Table  
Mesa



## Structure • Estructura



White  
Blanco



Black  
Negro

## Top • Sobre



Iroko

## Materials

Structure: Steel with cathaphoretic coating process and micro textured powder coated polyester paint.  
Top: FSC/PEFC certificated iroko wood.

## Materiales

Estructura: Acero con cataforesis y pintura poliéster en acabado micro texturado.  
Sobre: Madera de iroko certificada FSC/PEFC.

## Product options

Ask for power socket options.

## Opciones

Pregúntanos por las opciones de electrificación.

## 285

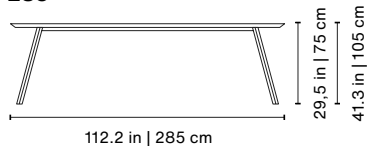

### Low 65 W

**Product weight • Peso del producto**  
125.7 lb | 57 kg

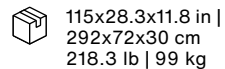

### Tall 65 W

**Product weight • Peso del producto**  
125.7 lb | 57 kg

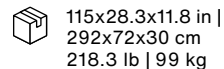

### Low 85 W

**Product weight • Peso del producto**  
138.9 lb | 63 kg

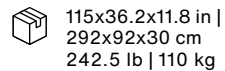

### Tall 85 W

**Product weight • Peso del producto**  
138.9 lb | 63 kg

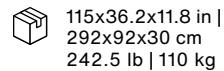

## 220

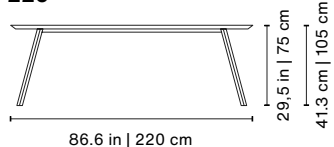

### Low 65 W

**Product weight • Peso del producto**  
97 lb | 44 kg

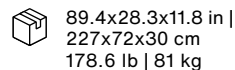

### Tall 65 W

**Product weight • Peso del producto**  
97 lb | 44 kg

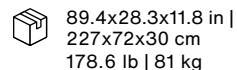

### Low 85 W

**Product weight • Peso del producto**  
114.6 lb | 52 kg

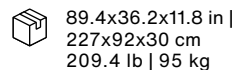

### Tall 85 W

**Product weight • Peso del producto**  
114.6 lb | 52 kg

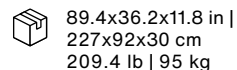

## 180

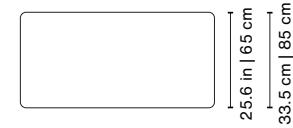
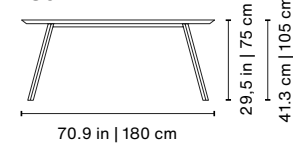

### Low 65 W rs barcelona

**Product weight • Peso del producto**  
79.4 lb | 36 kg

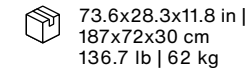

### Low 85 W

**Product weight • Peso del producto**  
92.6 lb | 42 kg

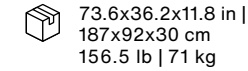

### Tall 65 W

**Product weight • Peso del producto**  
79.4 lb | 36 kg

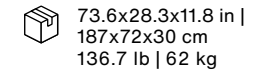

### Tall 85 W

**Product weight • Peso del producto**  
92.6 lb | 42 kg

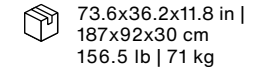

## 160

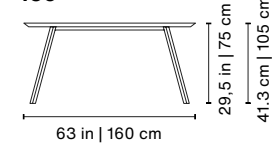

### Low 65 W

**Product weight • Peso del producto**  
70.5 lb | 32 kg

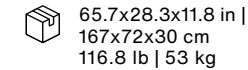

### Low 85 W

**Product weight • Peso del producto**  
81.6 lb | 37 kg

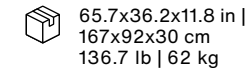

### Tall 65 W

**Product weight • Peso del producto**  
70.5 lb | 32 kg

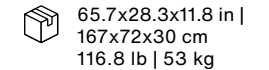

### Tall 85 W

**Product weight • Peso del producto**  
81.6 lb | 37 kg

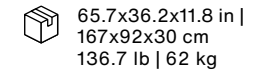

## 120

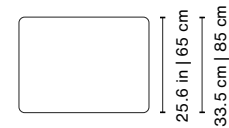
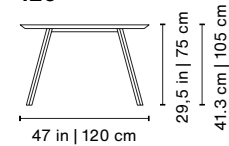

### Low 65 W

**Product weight • Peso del producto**  
52.9 lb | 24 kg

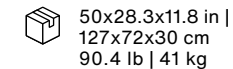

### Low 85 W

**Product weight • Peso del producto**  
61.7 lb | 28 kg

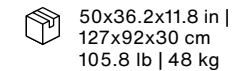

### Tall 65 W

**Product weight • Peso del producto**  
52.9 lb | 24 kg

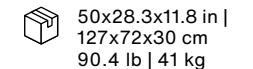

### Tall 85 W

**Product weight • Peso del producto**  
61.7 lb | 28 kg

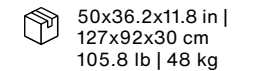

## 120 Square • 120 Cuadrada

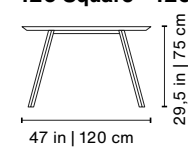

**Product weight • Peso del producto**  
105.8 lb | 48 kg

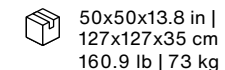

**100 Square • 100 Cuadrada**

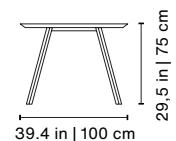

**Product weight • Peso del producto**  
92.6 lb | 42 kg

 42.1x42.1x13.8 in |  
107x107x35 cm  
138.9 lb | 63 kg

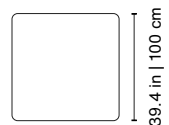

**100 Round • 100 Redonda**

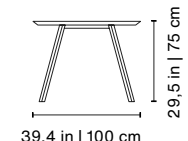

**rs barcelona**

**Product weight • Peso del producto**  
90.4 lb | 41 kg

 42.1x42.1x13.8 in |  
107x107x35 cm  
136.7 lb | 62 kg

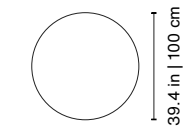

**85 Square • 85 Cuadrada**

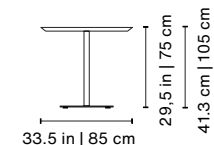

**Low**

**Product weight • Peso del producto**  
75 lb | 34 kg

 36.2x36.2x13.8 in |  
92x92x35 cm  
108 lb | 49 kg

**Tall**

**Product weight • Peso del producto**  
77.2 lb | 35 kg

 36.2x36.2x13.8 in |  
92x92x35 cm  
110.2 lb | 50 kg

**85 Round • 85 Redonda**

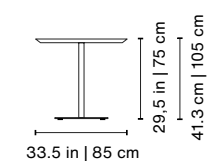

**Low**

**Product weight • Peso del producto**  
72.8 lb | 33 kg

 36.2x36.2x13.8 in |  
92x92x35 cm  
105.8 lb | 48 kg

**Tall**

**Product weight • Peso del producto**  
75 lb | 34 kg

 36.2x36.2x13.8 in |  
92x92x35 cm  
108 lb | 49 kg

**65 Square • 65 Cuadrada**

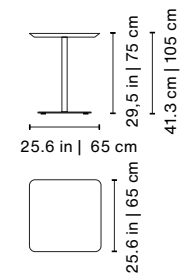

**Low**

**Product weight • Peso del producto**  
61.7 lb | 28 kg

 28.3x28.3x13.8 in |  
72x72x35 cm  
83.8 lb | 38 kg

**Tall**

**Product weight • Peso del producto**  
63.9 lb | 29 kg

 28.3x28.3x13.8 in |  
72x72x35 cm  
86 lb | 39 kg

**65 Round • 65 Redonda**

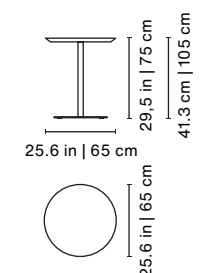

**Low**

**Product weight • Peso del producto**  
59.5 lb | 27 kg

 28.3x28.3x13.8 in |  
72x72x35 cm  
81.6 lb | 37 kg

**Tall**

**Product weight • Peso del producto**  
61.7 lb | 28 kg

 28.3x28.3x13.8 in |  
72x72x35 cm  
83.8 lb | 38 kg

**120 Round • 120 Redonda**

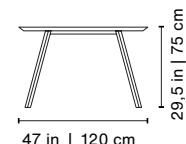

**Product weight • Peso del producto**  
103.6 lb | 47 kg

 50x50x13.8 in |  
127x127x35 cm  
158.7 lb | 72 kg

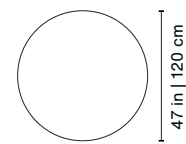

# Crew

Rafael Rodríguez, 2023  
Stand  
Grada



**Colours • Colores**



White  
Blanco



Black  
Negro



Red  
Rojo



Blue  
Azul



Green  
Verde



Grey  
Gris



Terracotta  
Terracota



Yellow  
Amarillo

**Materials**

Structure: Steel with cataphoretic coating process and micro textured powder coated polyester paint.  
Step: Steel with cataphoretic coating process and scratch resistance textured powder coated polyester paint.

**Materiales**

Estructura: Acero con cataforesis y pintura poliéster con acabado micro texturado.  
Escalón: Acero con cataforesis y pintura poliéster en acabado texturado con mayor resistencia a los arañazos.

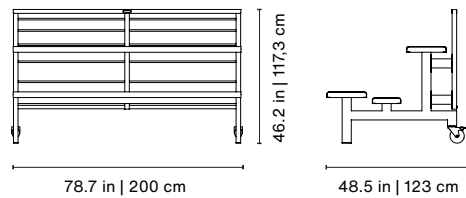

**Product weight • Peso del producto** 331 lb | 150 kg

82x41,3x14,2 in | 208x105x36 cm  
364 lb | 165 kg



Crew comfortably seats up 8 people.  
Crew acomoda hasta a 8 personas.

# Crew Accessories

Rafael Rodríguez, 2023  
Covered Outdoor counter bar  
Barra de exterior cubierto



**Counter bar • Barra**



Iroko

**Materials**

Structure: Steel with cataphoretic coating process and micro textured powder coated polyester paint.  
Counter bar: FSC/PEFC certificated iroko wood.

**Materiales**

Estructura: Acero con cataforesis y pintura poliéster con acabado micro texturado.  
Barra: Madera de iroko certificada FSC/PEFC.

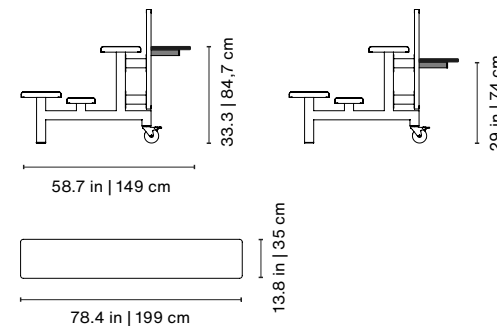

**Product weight • Peso del producto** 29 lb | 13 kg

# Ombra

Emiliana Design Studio, 2019

Stool  
Taburete



## Colours • Colores



White  
Blanco



Black  
Negro



Red  
Rojo



Blue  
Azul



Green  
Verde



Grey  
Gris



Terracotta  
Terracota



Yellow  
Amarillo

## Materials

Steel with cataphoretic coating process with micro textured powder coated polyester paint.

## Product options

With or without backrest.

## Bar

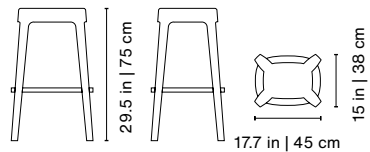

**Product weight • Peso del producto** 19.6 lb | 8,9 kg



20.1x17.5x42.9 in | 51x44,5x109 cm  
22 lb | 10 kg

## Counter

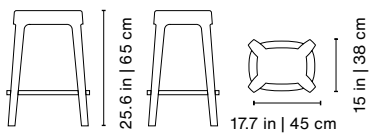

**Product weight • Peso del producto** 17.9 lb | 8,1 kg



18.9x16.5x26.4 in | 48x42x67 cm  
20 lb | 9 kg

## Low • Bajo

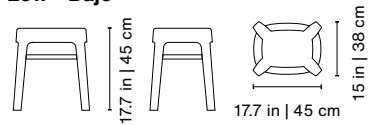

**Product weight • Peso del producto** 13.2 lb | 6 kg



17.3x15.1x19.3 in | 44x38,5x49 cm  
14.3 lb | 6,5 kg

## Bar with backrest • Bar con respaldo

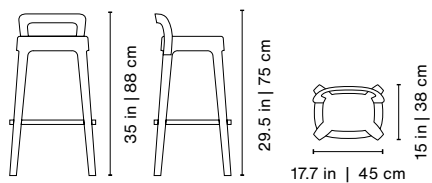

**Product weight • Peso del producto** 20.9 lb | 9,5 kg



20.1x17.5x42.9 in | 51x44,5x109 cm  
23.1 lb | 10,5 kg

## Counter with backrest • Counter con respaldo

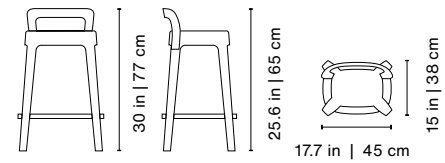

**Product weight • Peso del producto** 19 lb | 8,7 kg



18.9x16.5x39.4 in | 48x42x100 cm  
22 lb | 10 kg

## Low with backrest • Bajo con respaldo



**Product weight • Peso del producto** 14.5 lb | 6,6 kg



17.3x15.1x28 in | 44x38,5x71 cm  
15 lb | 7 kg

# On the Road

Stone Designs, 2008

Bench  
Banco



## Upholstery • Tapizado



0983



0193



0133

## Strap • Cinta



Grosella



Roto



Royal

## Materials

Structure: Cross-ply beech base with solid beech legs.  
Upholstery: Uniform Mélange from Kvadrat (68% wool, 22% nylon and 10% polyester).  
Strap: 100% polyester.  
Stuffing: Mix of natural and synthetic fibres.

## Materiales

Estructura: Base en contrachapado de madera de haya y patas de haya macizas.  
Tapizado: Uniform Mélange de Kvadrat (68% lana, 22% nylon y 10% poliéster).  
Cinta: 100% poliéster.  
Relleno: Mezcla de fibras naturales y sintéticas.

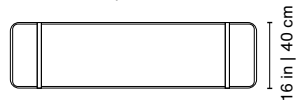
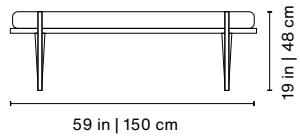

Product weight • Peso del producto 28.7 l | 13 kg



60.2x16.9x16.5 in | 152x43x42 cm  
33 lb | 15 kg

# Mon Oncle

Mermelada Estudio, 2014

Barbecue  
Barbacoa



## Colours • Colores

Blue  
AzulGreen  
VerdeGrey  
Gris

## Materials

Structure: Steel with cathophoretic coating process and micro textured powder coated polyester paint.  
Grill: Stainless steel.  
Inside tray: Stainless steel.  
Strap: Fabric and leather handle.

## Materiales

Estructura: Acero con cataforesis y pintura poliéster con acabado micro texturado.  
Parrilla: Acero inoxidable.  
Bandeja interior: Acero inoxidable.  
Cinta: Tela y asa de piel.

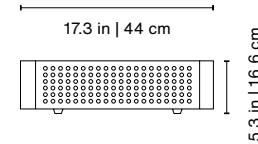
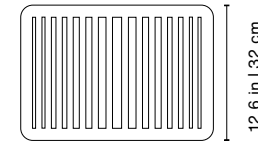

Product weight • Peso del producto 13.9 lb | 6,3 kg



19.7x15.6x7.1 in | 50x39x18 cm  
17.6 lb | 8 kg



# Wall Champions 1

Rafael Rodríguez, 2007

Coat hook  
Colgador



## Materials

Cast aluminium.

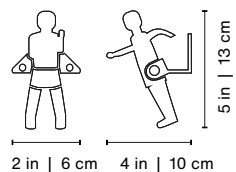

Product weight • Peso del producto 0.7 lb | 0,3 kg

3.2x6.3x4.3 in | 8x16x11 cm  
0.7 lb | 0,3 kg

## Materiales

Aluminio fundido.

# Wall Champions 4

Rafael Rodríguez, 2007

Coat rack  
Colgador



## Materials

Player: Cast aluminium.  
Rod: Satin finish steel.  
Handle: FSC/PEFC certificated iroko wood.

## Materiales

Jugador: Aluminio fundido.  
Barra: Acero en acabado satinado.  
Mangos: Madera de iroko certificada FSC/PEFC.

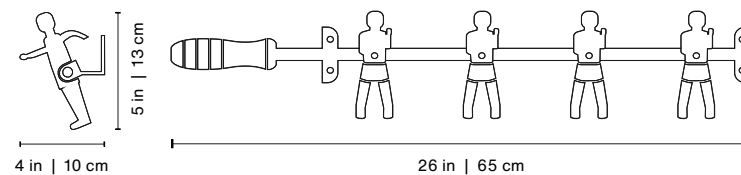

Product weight • Peso del producto 4.5 lb | 2 kg

28x6.3x4.3 in | 71x16x11 cm  
5 lb | 2,3 kg



# Make it extraordinary.



<b>Customisation</b> • Customización	166
<b>Design &amp; colours</b> • Diseño & colores	170
<b>Design &amp; quality</b> • Diseño & calidad	172
<b>Design &amp; care</b> • Diseño & cuidado	174

# Customisation • Customización

Customisation is one of our brand values. We know how important it is to be flexible to fit the needs and requirements of each project and client, and add that touch of distinction that makes it so special. Turn our products into exclusive pieces by customising them with the options we offer you.

La personalización es uno de los valores de nuestra marca. Sabemos lo importante que es adaptarse a las necesidades y exigencias de cada proyecto y cliente y añadir ese toque de distinción que lo hace tan especial. Convierte nuestros productos en piezas exclusivas personalizándolas con las opciones que te proponemos.

## Football and Dining Tables • Futbolines y Futbolines Mesa

Once you have chosen the football table or the football dining table that suits your project, it is time to make it unique.

Una vez elegido el modelo de futbolín o futbolín-mesa que se acomoda a las características de tu proyecto, llega el momento de hacerlo único.

### Standard customisation

Customisation options included when you order a football table.

#### Choose your lineup

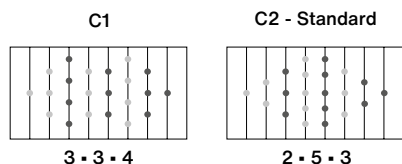

#### Players • Gender • Skin colour

Choose the player, gender and skin colour that best suits your kind of play.



Girl players only available with two feet.

Jugadoras chicas solo disponibles con dos pies.

### Customización básica

Las siguientes opciones de customización se incluyen con la compra del futbolín.

#### Elige tu alineación

#### Jugadores • Género • Color de piel

Elige el tipo de jugadores, género y color de piel que se adapta a tu juego.

### Custom

The following options have an extra cost informed in our price list and customisation guide.

### Customización

Las siguientes modificaciones tienen un coste extra que se indica en nuestras tarifas y en la guía de customización.

**The colour you wish.**  
Choose the specific RAL colour for the steel structure (powder coated polyester paint).

**El color deseado.**  
Elige el color RAL concreto para la estructura metálica (pintura poliéster en polvo).

**The brand, a distinguishing feature.**  
Include the logo on the outer goal ends (vinyl).

**La marca, un signo de identidad.**  
Incorpora el logo en los laterales cortos del futbolín (vinilo).

**Add colour to the legs.**  
Change the iroko wooden legs to walnut or oak wood or add colour without losing its natural appearance (stained).

**Dale color a las patas.**  
Cambia las patas de madera de iroko por nogal o roble o añádeles color sin que pierda su aspecto natural (lacado).

**Add the logo in the center of the field (vinyl).**  
Incluye el logo en el centro del campo (vinilo).

**Include the logo on players chest (screen printing).**  
Añade el logo en el pecho de los jugadores (serigrafía).

**Add numbers and names on players back (vinyl).**  
Pon números y nombres en la espalda de los jugadores (vinilo).

### Special players customisation examples.

### Ejemplos de customizaciones especiales de jugadores.



## Ping Pong Tables • Mesas de Ping Pong

RS Barcelona ping pong tables are much more than just a playing pitch. They are a gathering point between playability and design, with a high aesthetic value to which you can add your personal touch.

The following options have an extra cost informed in our price list and customisation guide.

Las mesas de ping-pong RS Barcelona son mucho más que un terreno de juego. Son un punto de encuentro entre jugabilidad y diseño, con un alto valor estético al que puedes añadir tu toque personal.

Las siguientes modificaciones tienen un coste extra que se indica en nuestras tarifas y en la guía de customización.

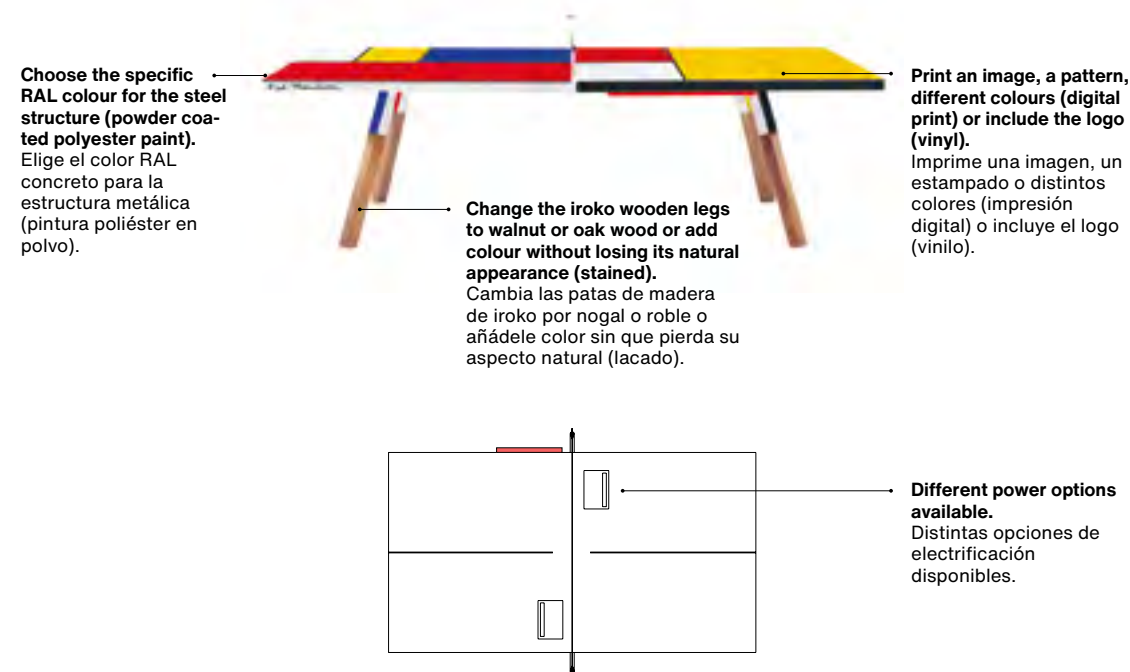

## Pool Tables • Billares

Pool table is an elegant and precision game. We can emphasize its excellence by customising certain details of the piece so that it blends perfectly with the environment and shows all its appeal.

The following options have an extra cost informed in our price list and customisation guide.

El billar es un juego elegante y de precisión. Una precisión que podemos enfatizar customizando ciertos aspectos de la pieza para que se mimetice con el espacio y luzca en toda su intensidad y atractivo.

Las siguientes modificaciones tienen un coste extra que se indica en nuestras tarifas y en la guía de customización.



# Design & colours • Diseño y colores

The colours and textures used by RS Barcelona express timelessness and harmony. With striking purity and sensuality, they enhance the beauty of our items, allowing you to combine tones and create your own colour palette.

Los colores y texturas RS Barcelona hablan de atemporalidad y armonía. Emocionan con su pureza y sensualidad y realzan la belleza de nuestras piezas, permitiendo mezclar tonalidades y crear tu propia paleta de color.

## Metal

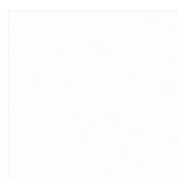

**White**  
Blanco  
RAL 9016  
Textured



**Black**  
Negro  
RAL 9005  
Textured



**Red**  
Rojo  
RAL 3020  
Textured



**Blue**  
Azul  
RAL 5001  
Textured

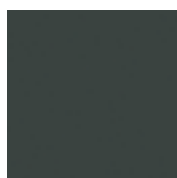

**Green**  
Verde  
NCS S 7005-B80G  
Textured

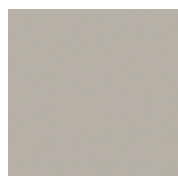

**Grey**  
Gris  
RAL 7044  
Textured



**Yellow**  
Amarillo  
RAL 1016  
Textured



**Terracotta**  
Terracota  
NCS S 4040-Y80R  
Textured



**Inox**

## Marble



**White Carrara**



**Black Marquina**

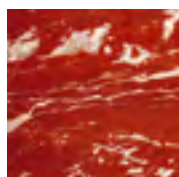

**Red Francia**

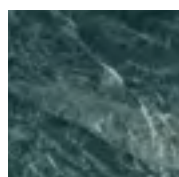

**Green Aver**

## Wood & HPL • Madera & HPL

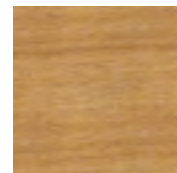

**Iroko Wood**  
Madera de Iroko



**Walnut Wood**  
Madera de Nogal



**Oak Wood**  
Madera de Roble

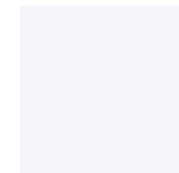

**White HPL**  
HPL Blanco



**Black HPL**  
HPL Negro



**Green HPL**  
HPL Verde



**Grey HPL**  
HPL Gris

## Textile • Textil



**Black**  
Negro

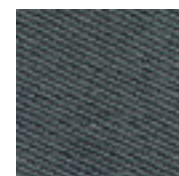

**Grey**  
Gris



**Burgundy**  
Granate



**Grey Blue**  
Azul Gris

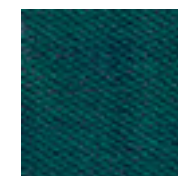

**Green**  
Verde

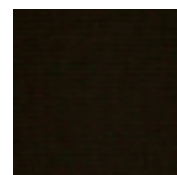

**Black**  
Negro

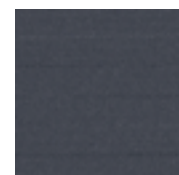

**Carbon**  
Carbón



**White**  
Blanco

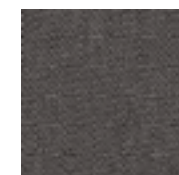

**Dark Taupe**

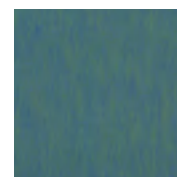

**0983**

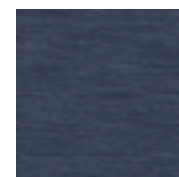

**0193**

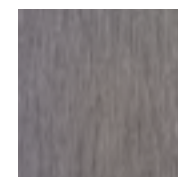

**0133**

## Design & quality • Diseño y calidad

Top quality, the ability to withstand intensive use and durability. These are concepts we take for granted when looking for an item to incorporate in our lives. Durability is the cornerstone of all the decisions we make in our product development process. That's why we select top-quality materials and manufacturing processes that guarantee the optimal toughness and longevity of our products.

We always use raw materials that meet the highest standards of quality, sustainability and social responsibility. We take the greatest care in sourcing our materials, ensuring that they can be subsequently transformed and reused, and that they don't contain any chemical components harmful to the ecosystem. This is crucial in order to create and manufacture in a way that respects people's health and the environment.

The RS Barcelona Commitment, along with the quality seals and labels of the materials we use to manufacture our items, are all displayed on our website.

[rs-barcelona.com/en/about-us/sustainability/](https://rs-barcelona.com/en/about-us/sustainability/)

Máxima calidad, resistencia al uso intenso y larga duración. Son conceptos que damos por hecho cuando buscamos una pieza que integrar a nuestra vida. La durabilidad es el eje sobre el que basamos todas las decisiones que tomamos en el desarrollo de nuestras piezas. Por ello, seleccionamos materiales de alta calidad y procesos de fabricación que garanticen la mayor resistencia y longevidad a nuestros productos.

Trabajamos siempre con materias primas que cumplan con los más altos estándares de calidad, sostenibilidad y responsabilidad social. Y conocer su procedencia es nuestro modo de garantizar que pueden ser transformados y reutilizados, y que no contienen componentes químicos nocivos para el ecosistema. Para crear y fabricar de forma respetuosa con la salud de las personas y el medio ambiente.

Consulta en nuestra web, el Compromiso RS Barcelona y los sellos y etiquetas de calidad de los materiales que usamos en la producción de nuestras piezas.

[rs-barcelona.com/es/sobre-nosotros/sostenibilidad/](https://rs-barcelona.com/es/sobre-nosotros/sostenibilidad/)



## Design & care • Diseño & cuidado

The products we love and appreciate, those that are part of our everyday luxury, also deserve luxury care. Our pieces are crafted of high quality materials to last over time.

Although age can catch up with us, it is possible to preserve their original appeal and beauty by caring for them regularly to protect them from environmental elements and the effects of time, specially the pieces you enjoy outdoors.

Carefully read the advice and tips detailed in the User Manual that is included with each product and which you can download by scanning this QR code.

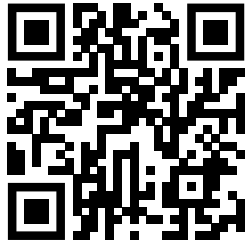

[rsbarcelona.com/en/usersmanual/](https://rsbarcelona.com/en/usersmanual/)

Los productos que amamos y valoramos, esos que forman parte de nuestro lujo cotidiano, también precisan cuidados de lujo. Nuestras piezas están elaboradas con materiales de alta calidad para resistir y perdurar en el tiempo.

Aunque los años no perdonen, es posible conservar su apariencia y su belleza original protegiéndolos y cuidándolos periódicamente para preservarlos de los agentes externos, del clima y del tiempo, sobre todo los productos que disfrutas al exterior.

Lee atentamente los consejos sobre cuidado y mantenimiento indicados en el Manual de usuario que se incluye junto con todos nuestros productos y que puedes consultar escaneando este código QR.

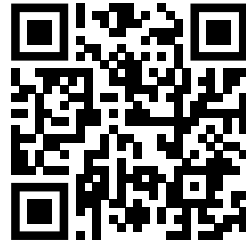

[rsbarcelona.com/es/manualusuario/](https://rsbarcelona.com/es/manualusuario/)



**RS Barcelona Book**

Copyright © 2023 RS Barcelona

**Art direction & graphic design · Dirección de arte y diseño gráfico**

Aimée Duchamp

**Copywriting · Redacción**

María Carrasco

**Photography · Fotografía**

Meritxell Arjalaguer

Joan Cabacés

Carlos Iglíki

Blanca Muntadas

Kristina Kiselichka

Siddharth Gautam Singh

**Creative production consultant · Consultora creativa en producción impresa**

I am Nuria

iamnuria.com

**Printed by · Impreso por**

Impressus

impressus.es

**This book was printed on paper certified by · Este libro ha sido impreso en papel certificado por:**

FSC® FSC-C110625

**Printed in · Impreso en Barcelona**

All rights reserved · Todos los derechos reservados

**Acknowledgments · Agradecimientos**

Genialidades

Hotel Alexandra

Hotel Seventy

Rilke

**Head Office & Showroom**

C. Còrsega, 365

08037, Barcelona

Spain

Phone: +34 936589503

E-mail: info@rsbarcelona.com

**Factory & Warehouse**

C. de la Barca, 7-9

Polígono Industrial La Flora-Fou

08640 Olesa de Montserrat

Barcelona, Spain

**RS Barcelona LLC (USA)**

E-mail: andrea@rsbarcelona.com

Phone: +1 424 249 9646

Los Angeles, CA

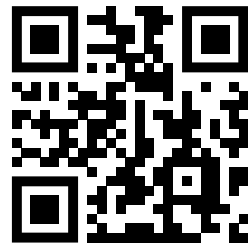
[rsbarcelona.com](https://rsbarcelona.com)

Scann this code and find out our intense living products.

